



FS-1020MFP FS-1220MFP

OPERATION GUIDE



This Operation Guide is for models FS-1020MFP and FS-1220MFP.

This Operation Guide is intended to help you operate the machine correctly, perform routine maintenance and take a simple troubleshooting action as necessary, so that you can always use the machine in good condition.

We recommend the use of our own brand supplies. We will not be liable for any damage caused by the use of third party supplies in this machine.

A label shown in the illustration assures that the supplies are our own brand.

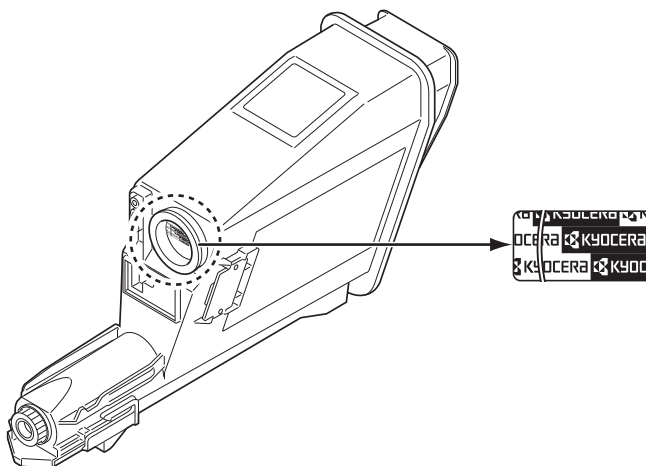

Included Guides

The following guides are supplied with the machine. Refer to them as necessary.

Quick Installation Guide	Describes the procedures for installation of the machine.
Safety Guide	Provides safety and cautionary information for the installation and use of the machine. Be sure to read this guide before using the machine.
Safety Guide (FS-1020MFP/FS-1025MFP/FS-1120MFP/ FS-1125MFP/FS-1220MFP/FS-1320MFP/ FS-1325MFP)	Describes the machine installation space, cautionary space, and other information. Be sure to read this guide before using the machine.

Product Library disc

Operation Guide (This Guide)	Describes how to load paper, basic copy, print and scan operations, and troubleshooting.
KYOCERA Client Tool User Guide	Describes how to use KYOCERA Client Tool. KYOCERA Client Tool is a software program that is installed on your computer to enable you to configure machine settings.
Printer Driver User Guide	Describes how to install the printer driver and use printer functionality.
KYOCERA Net Viewer User Guide	Describes how to monitor the network printing system with KYOCERA Net Viewer.

Contents

1	Machine Parts	1-1
	Front Machine Components	1-2
	Rear Machine Components	1-3
	Operation Panel	1-4
2	Preparation	2-1
	Connections	2-2
	Loading Paper	2-4
	Loading Originals	2-16
	Installing and Uninstalling Drivers and Utilities	2-17
	Machine Settings	2-22
	Configuration	2-36
	Printing the Status Page	2-42
3	Copying	3-1
	Basic Operation	3-2
	Manual Duplex	3-3
	Using Programs	3-5
	Copying Functions	3-5
	ID Card Copy	3-6
4	Printing	4-1
	Printing from Application Software	4-2
	About GX Driver	4-2
	Manual Duplex	4-3
	Print Box	4-5
	Changing the Default Printer Driver Settings (Windows 7 for example)	4-6
5	Scanning	5-1
	Push Scan	5-2
	Using Programs	5-3
	Quick Scan (Scan to PDF/Scan to Email/Scan to Folder)	5-4
	Scanning using TWAIN/WIA	5-5
6	Maintenance	6-1
	General Information	6-2
	Toner Container Replacement	6-2
	Maintenance Kit Replacement	6-5
	Cleaning the Machine	6-5
	Maintenance Menu	6-7
	Prolonged Non-Use and Moving of the Machine	6-8
7	Troubleshooting	7-1
	Solving Malfunctions	7-2
	Error Messages	7-7
	Clearing Paper Jams	7-9
8	Appendix	8-1
	Specifications	8-2
	Index	Index-1

Legal and Safety Information



CAUTION NO LIABILITY IS ASSUMED FOR ANY DAMAGE CAUSED BY IMPROPER INSTALLATION.

Notice

The information in this guide is subject to change without notification. Additional pages may be inserted in future editions. The user is asked to excuse any technical inaccuracies or typographical errors in the present edition.

No responsibility is assumed if accidents occur while the user is following the instructions in this guide. No responsibility is assumed for defects in the machine's firmware (contents of its read-only memory).

This guide, and any copyrightable subject matter sold or provided with or in connection with the sale of the machine, are protected by copyright. All rights are reserved. Copying or other reproduction of all or part of this guide, or any copyrightable subject matter without the prior written consent of KYOCERA Document Solutions Inc. is prohibited. Any copies made of all or part of this guide, or any copyrightable subject must contain the same copyright notice as the material from which the copying is done.

Regarding Tradenames

Adobe Acrobat, and Flash are registered trademarks of Adobe Systems Incorporated.

Macintosh and Mac OS are trademarks of Apple Inc., registered in the U.S. and other countries.

Microsoft, MS-DOS, and Windows are registered trademarks of Microsoft Corporation in the U.S.A. and/or other countries.

ENERGY STAR is a U.S. registered mark.

All other brand and product names are registered trademarks or trademarks of their respective companies.

Compliance and Conformity

This equipment has been tested and found to comply with the limits for a Class B digital device, pursuant to Part 15 of the FCC Rules. These limits are designed to provide reasonable protection against harmful interference in a residential installation. This equipment generates, uses and can radiate radio frequency energy and, if not installed and used in accordance with the instructions, may cause harmful interference to radio communications. However, there is no guarantee that interference will not occur in a particular installation. If this equipment does cause harmful interference to radio or television reception, which can be determined by turning the equipment off and on, the user is encouraged to try to correct the interference by one or more of the following measures:

- Reorient or relocate the receiving antenna.
- Increase the separation between the equipment and receiver.
- Connect the equipment into an outlet on a circuit different from that to which the receiver is connected.
- Consult the dealer or an experienced radio/TV technician for help.
- The use of a non-shielded interface cable with the referenced device is prohibited.

CAUTION — The changes or modifications not expressly approved by the party responsible for compliance could void the user's authority to operate the equipment.

This device complies with Part 15 of FCC Rules.

Operation is subject to the following two conditions; (1) this device may not cause interference, and (2) this device must accept any interference, including interference that may cause undesired operation of the device.

* The above warning is valid only in the United States of America.

Interface connectors

IMPORTANT Be sure to power off the machine before connecting or disconnecting an interface cable. For protection against static electricity discharge to the machine's internal electronics through the interface connector(s), cover any interface connector that is not in use with the protective cap supplied.



Note Use shielded interface cables.

CDRH Regulations

The Center for Devices and Radiological Health (CDRH) of the U.S. Food and Drug Administration implemented regulations for laser products on August 2, 1976. These regulations apply to laser products manufactured after August 1, 1976. Compliance is mandatory for products marketed in the United States. A label indicating compliance with the CDRH regulations must be attached to laser products marketed in the United States.

Canadian Department of Communications Compliance Statement

This Class B digital apparatus complies with Canadian ICES-003.

Avis de conformité aux normes du ministère des Communications du Canada

Cet appareil numérique de la classe B est conforme à la norme NMB-003 du Canada.

Safety Instructions Regarding the Disconnection of Power

Caution: The power plug is the main isolation device! Other switches on the equipment are only functional switches and are not suitable for isolating the equipment from the power source.

VORSICHT: Der Netzstecker ist die Hauptisoliervorrichtung! Die anderen Schalter auf dem Gerät sind nur Funktionsschalter und können nicht verwendet werden, um den Stromfluß im Gerät zu unterbrechen.

Energy Saving Control Function

To reduce energy consumption while in a waiting state, the device comes equipped with an energy saving control function for switching to **Sleep Mode** as well as **Power Off Mode** where power consumption is automatically reduced to a minimum after a certain amount of time elapses since the device was last used.

Sleep Mode

The device automatically enters Sleep Mode when approximately 1 minute has passed since the device was last used. The amount of time of no activity that must pass before Sleep Mode is activated may be lengthened by changing the Auto sleep setting. For details, refer to *Device Defaults Tab* on page 2-38.

Power Off Mode

The device automatically turns its power off when 1 hour has passed since the device was last used. The amount of time of no activity that must pass before Power Off Mode is activated may be lengthened by changing the Power Off Timer setting. For details, refer to *Device Defaults Tab* on page 2-38.

In case of not using the machine for an extended period of time



CAUTION If this machine will be left unused for an extended period (e.g. overnight), turn it off at the power switch. If the machine will not be used for an even longer period of time (e.g. vacation), remove the power plug from the outlet as a safety precaution.

CAUTION Remove paper from the cassettes and seal it in the paper storage bag to protect it from humidity.

Duplex Printing

This machine includes duplex printing as a standard function. For example, by printing two single-sided originals onto a single sheet of paper as a duplex printing, it is possible to lower the amount of paper used.

Printing in duplex mode reduces paper consumption and contributes to the conservation of forest resources. Duplex mode also reduces the amount of paper that must be purchased, and thereby reduces cost. It is recommended that machines capable of duplex printing be set to use duplex mode by default.

Resource Saving - Paper

For the preservation and sustainable use of forest resources, it is recommended that recycled as well as virgin paper certified under environmental stewardship initiatives or carrying recognised ecolabels, which meet EN 12281:2002*¹ or an equivalent quality standard, be used.

This machine also supports printing on 64 g/m² paper. Using such paper containing less raw materials can lead to further saving of forest resources.

*1: EN12281:2002 "Printing and business paper - Requirements for copy paper for dry toner imaging processes"

Your sales or service representative can provide information about recommended paper types.

Environmental benefits of "Power Management"

To reduce power consumption when idle, this machine is equipped with a power management function that automatically activates energy-saving mode when the machine is idle for a certain period of time. Although it takes the machine a slight amount of time to return to READY mode when in energy-saving mode, a significant reduction in energy consumption is possible.

It is recommended that the machine be used with the activation time for energy-saving mode set to the default setting.

Energy Star (ENERGY STAR®)



We have determined as a company participating in ENERGY STAR® that this product has earned the ENERGY STAR®.

ENERGY STAR® is a voluntary energy efficiency program with the goal of developing and promoting the use of products with high energy efficiency in order to help prevent global warming. By purchasing ENERGY STAR® qualified products, customers can help reduce emissions of greenhouse gases during product use and cut energy-related costs.

Legal Restriction on Copying/Scanning

It may be prohibited to copy/scan copyrighted material without permission of the copyright owner.

Copying/Scanning the following items is prohibited and may be penalized by law. It may not be limited to these items. Do not knowingly copy/scan the items that are not to be copied/scanned.

- Paper money
- Bank note
- Securities
- Stamp
- Passport
- Certificate

Local laws and regulations may prohibit or restrict copying/scanning of other items not mentioned above.

Safety Conventions in This Guide

The sections of this guide and parts of the machine marked with symbols are safety warnings meant to protect the user, other individuals and surrounding objects, and ensure correct and safe usage of the machine. The symbols and their meanings are indicated below.



WARNING: Indicates that serious injury or even death may result from insufficient attention to or incorrect compliance with the related points.



CAUTION: Indicates that personal injury or mechanical damage may result from insufficient attention to or incorrect compliance with the related points.

The following symbols indicate that the related section includes safety warnings. Specific points of attention are indicated inside the symbol.



.... [General warning]



.... [Warning of high temperature]

The following symbols indicate that the related section includes information on prohibited actions. Specifics of the prohibited action are indicated inside the symbol.



.... [Warning of prohibited action]



.... [Disassembly prohibited]

The following symbols indicate that the related section includes information on actions which must be performed. Specifics of the required action are indicated inside the symbol.



.... [Alert of required action]



.... [Remove the power plug from the outlet]



.... [Always connect the machine to an outlet with a ground connection]

Please contact your service representative to order a replacement if the safety warnings in this Operation Guide are illegible or if the guide itself is missing. (fee required)



Note An original which resembles a bank note closely may not be copied properly in some rare cases because this machine is equipped with a counterfeiting prevention function.

Environment

The service environmental conditions are as follows:

- Temperature: 50 to 90.5 °F (10 to 32.5 °C)
- Humidity: 15 to 80 %

However, adverse environmental conditions may affect the image quality. Avoid the following locations when selecting a site for the machine.

- Avoid locations near a window or with exposure to direct sunlight.
- Avoid locations with vibrations.
- Avoid locations with drastic temperature fluctuations.
- Avoid locations with direct exposure to hot or cold air.
- Avoid poorly ventilated locations.

If the floor is delicate against casters, when this machine is moved after installation, the floor material may be damaged.

During printing, some ozone is released, but the amount does not cause any ill effect to one's health. If, however, the machine is used over a long period of time in a poorly ventilated room or when printing an extremely large number of copies, the smell may become unpleasant. To maintain the appropriate environment for print work, it is suggested that the room be properly ventilated.

Cautions when Handling Consumables

Do not attempt to incinerate parts which contain toner. Dangerous sparks may cause burns.

Keep parts which contain toner out of the reach of children.

If toner happens to spill from parts which contain toner, avoid inhalation and ingestion, as well as contact with your eyes and skin.

- If you do happen to inhale toner, move to a place with fresh air and gargle thoroughly with a large amount of water. If coughing develops, contact a physician.
- If you do happen to ingest toner, rinse your mouth out with water and drink 1 or 2 cups of water to dilute the contents of your stomach. If necessary, contact a physician.
- If you do happen to get toner in your eyes, flush them thoroughly with water. If there is any remaining tenderness, contact a physician.
- If toner does happen to get on your skin, wash with soap and water.

Do not attempt to force open or destroy parts which contain toner.

Other precautions

After use, always dispose of the Toner Container in accordance with Federal, State and Local rules and regulations.

Store all consumables in a cool, dark location.

If the machine will not be used for an extended period of time, remove the paper from the cassette, return it to its original package and reseal it.



About the Operation Guide

This Operation Guide contains the following chapters:

1 Machine Parts

This chapter lists the names of different machine parts.

2 Preparation

This chapter explains how to start up the machine, load paper and originals, and use the application software included in the *Product Library* disc.

3 Copying

This chapter explains the functions you can use when copying.

4 Printing

This chapter explains the printing procedure from an application software.

5 Scanning

This chapter explains the functions you can use when scanning originals.

6 Maintenance

This chapter explains how to replace the toner container and how to care for your machine.

7 Troubleshooting

This chapter explains how to handle machine problems that may occur, such as paper jams.

8 Appendix

This chapter lists the machine specifications.

Conventions in This Guide

This manual uses the following conventions.

Convention	Description	Example
Italic Typeface	Used to emphasize a key word, phrase or reference to additional information.	Refer to <i>Connections</i> on page 2-2.
Bold	Used to denote buttons on the software.	To start printing, click OK .
Bracket Bold	Used to denote operation panel keys.	Press [Start] to start copying.
<i>Courier</i>	Indicates characters entered in the display on the operation panel.	1- appears in the display on the operation panel.
Note	Used to provide additional or useful information about a function or feature.	 Note Do not remove the toner container from the carton until you are ready to install it in the machine.
Important	Used to provide important information.	IMPORTANT Take care not to touch the drum and transfer roller (black) during cleaning.
Caution	Used to suggest mechanical damage as a result of an action.	CAUTION When removing a paper jam, pull the paper gently so as not to tear it. Torn pieces of paper are difficult to remove and may be easily overlooked, deterring the paper jam recovery.
Warning	Used to alert users to the possibility of personal injury.	WARNING If you are shipping the machine, remove and pack the developer unit and drum unit in a plastic bag and ship them separately from the machine.

1 Machine Parts

This chapter explains the following topics:

Front Machine Components	1-2
Rear Machine Components	1-3
Operation Panel	1-4

Front Machine Components

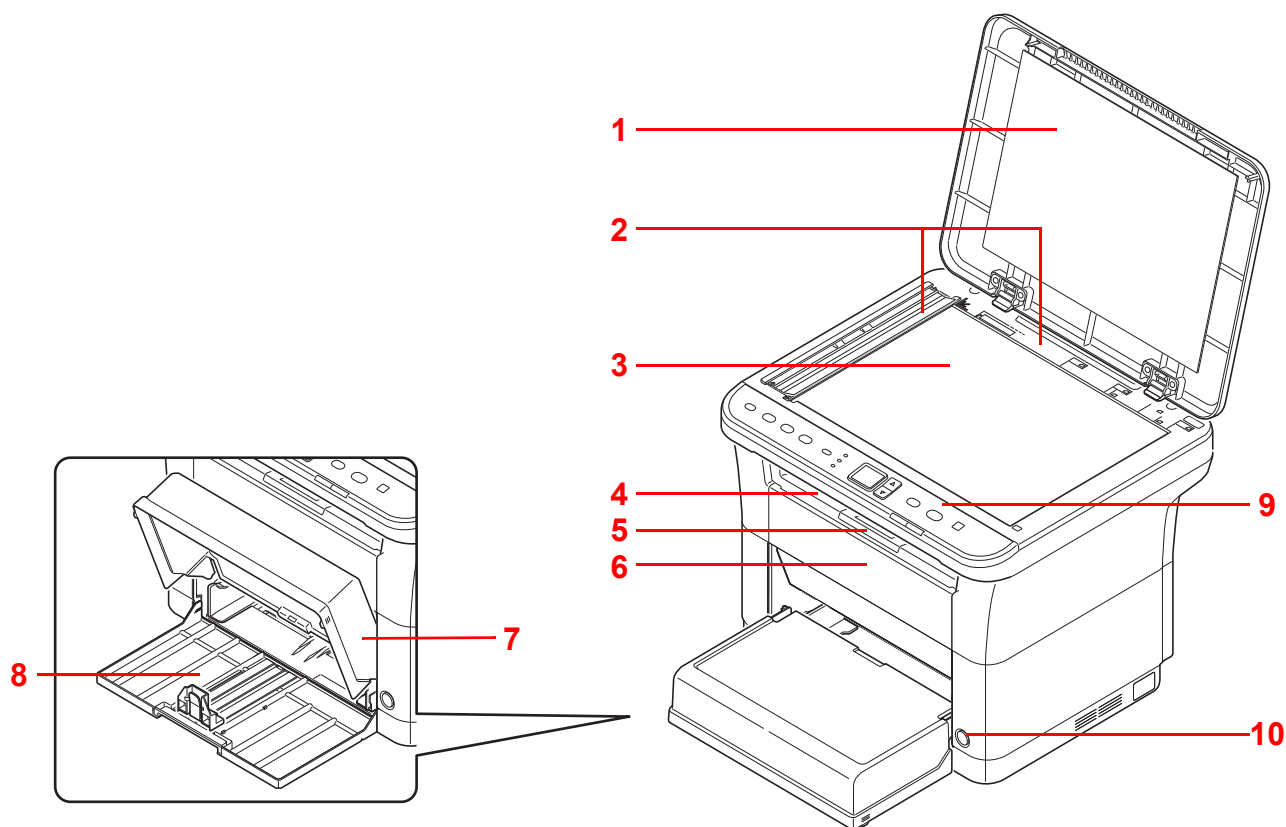

- 1 Original Cover
- 2 Original Size Indicator Plates
- 3 Platen
- 4 Inner Tray
- 5 Paper Stopper
- 6 Front Cover
- 7 Cassette Cover
- 8 Cassette
- 9 Operation Panel
- 10 Power Switch

Rear Machine Components

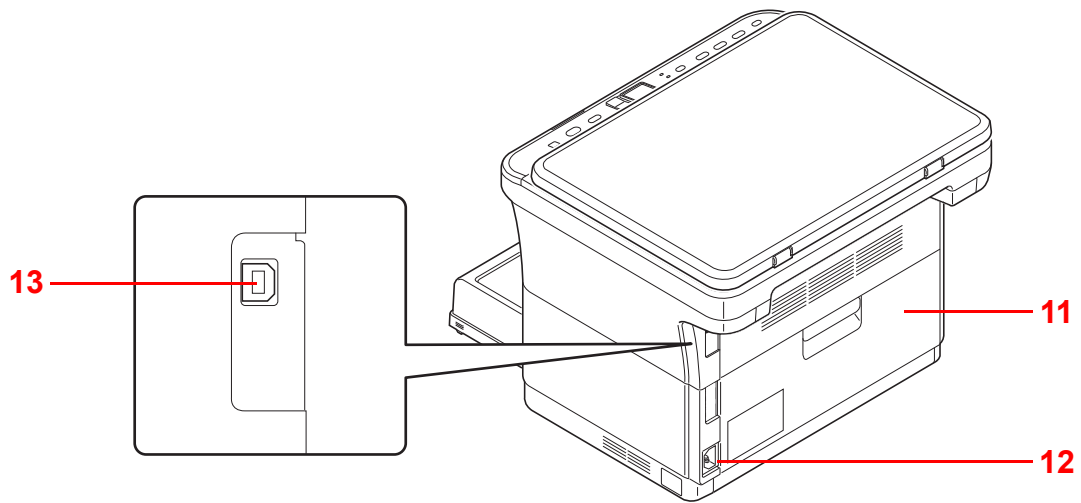

- 11** Rear Cover
- 12** Power Cord Connector
- 13** USB Interface Connector



Operation Panel

[ID Card Copy] key	Displays the ID Card Copy screen.
[Copy] key	Displays the Copy screen.
[Scan] key	Displays the Scan screen.
[Print Box] key	Displays the Print Box screen.

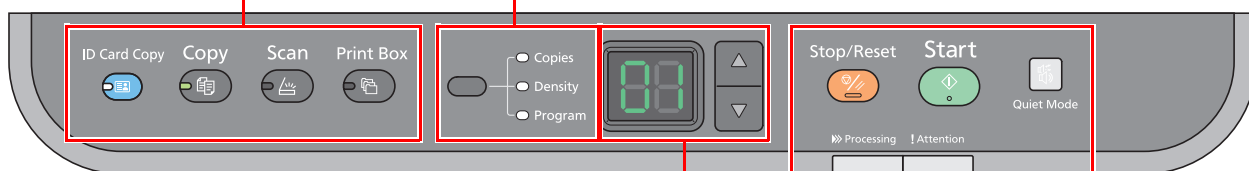
Mode Select key	<ul style="list-style-type: none"> Set the mode to Copies, Density, or Program. Press and hold for 5 seconds to print the status page. Refer to <i>Printing the Status Page</i> on page 2-42.
Copies indicator	Lights up when Copies is selected. Enter the number of copies.
Density indicator	Lights up when Density is selected. Adjust the copy density.
Program indicator	Lights up when Program is selected. Select the program number.



Display	<ul style="list-style-type: none"> Displays numerical values and settings such as the number of copies, and error codes. When the machine is in sleep mode, -- is displayed.
[▲] key / [▼] key	Increments/decrements numbers in the display.

[Stop/Reset] key	<ul style="list-style-type: none"> Cancels the printing job in progress. Returns settings to their default states. Hold down two seconds to pause printing. Hold down two seconds again to resume printing.
[Start] key	Starts copying and scanning operations.
Processing Indicator (Green) >>> Processing 	Flashes when the machine is processing data.
Attention Indicator (Amber) ! Attention 	Lights or flashes when an error occurs.
[Quiet Mode] key	Turns on Quiet Mode. Quiet Mode If you prefer quiet operation, press [Quiet Mode] to turn on Quiet Mode. When Quiet Mode is on, the print speed is slower.

2 Preparation

This chapter explains the following topics:

Connections	2-2
Loading Paper	2-4
Loading Originals.....	2-16
Installing and Uninstalling Drivers and Utilities	2-17
Machine Settings.....	2-22
Configuration.....	2-36
Printing the Status Page.....	2-42

Connections

This section explains how to start up the machine.

Connecting the USB Cable

Follow the steps as below for connecting the USB cable.

- 1 Connect the USB cable to the machine's USB interface connector.

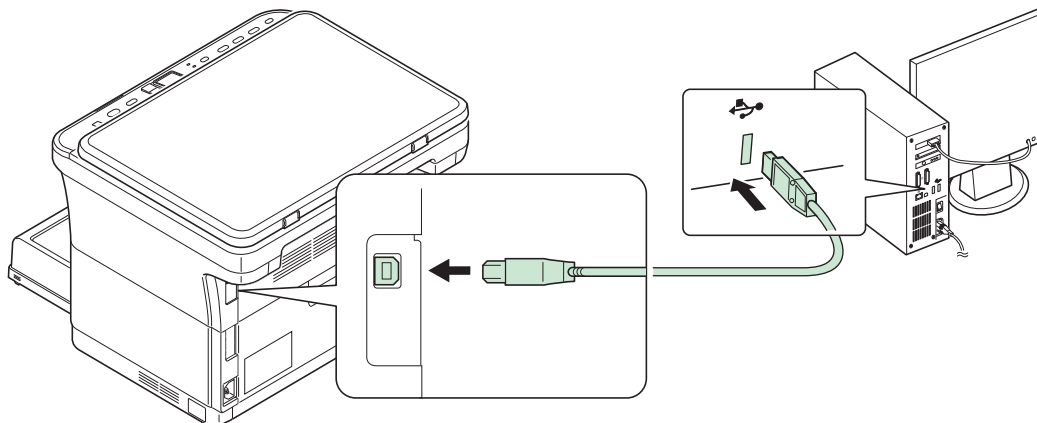

 **Note** Use a USB cable with a rectangular Type A plug and a square Type B plug. The USB cable should be shielded and no longer than 5 meters (16 feet) long.

- 2 Connect the other end of the USB cable to the computer's USB interface connector.

Connecting the Power Cord

Install the machine close to an AC wall outlet. If an extension cord is used, the total length of the power cord plus extension should be 5 meters (16 feet) or less.

 **Note** Only use the power cord supplied with the machine.

- 1 Connect the power cord to the power cord connector at the rear of the machine.

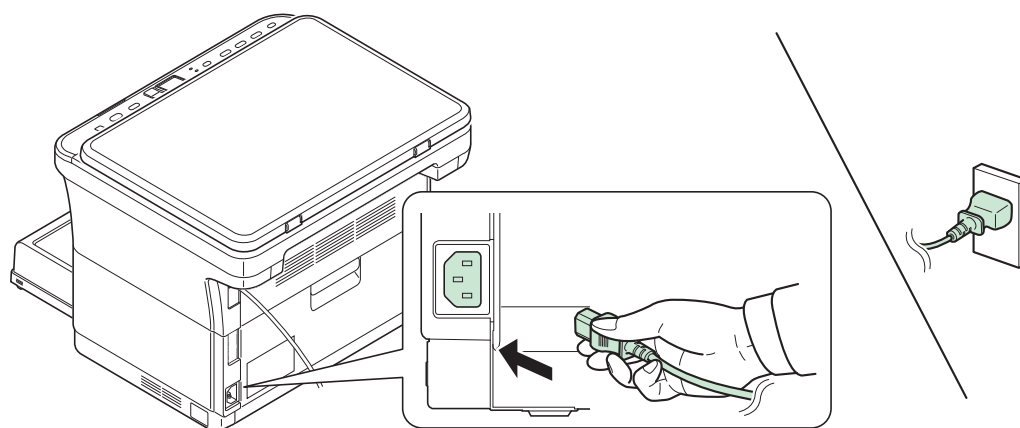

- 2 Connect the other end of the power cord to a power outlet.

- 3 Press the power switch to On. The machine begins to warm up.

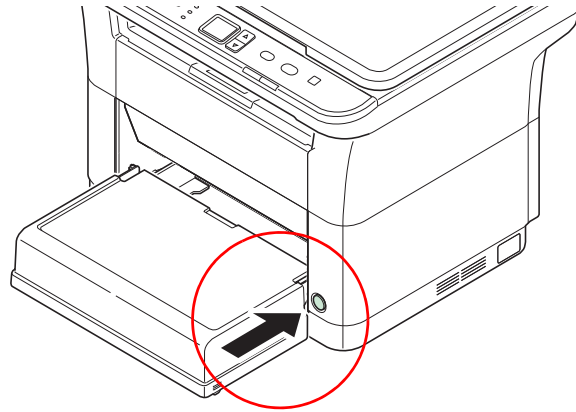

IMPORTANT If you install the toner container and switch on the power, a screen with two bars (—) rotating is shown on the display on the operation panel. When the machine is first switched on after toner installation, there will be a delay of approximately 7 minutes before the machine gets ready to use. Once 01 appears in the display on the operation panel, machine installation is complete.

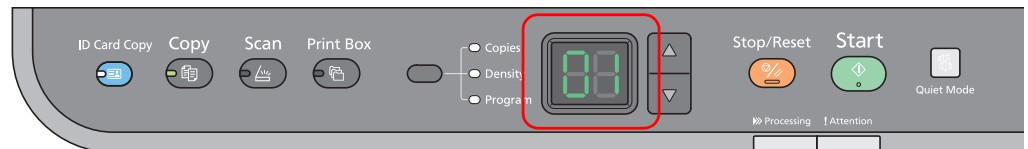

Starter Toner Container

The toner container packed with the new machine is a starter toner container. The starter toner container lasts an average of 700 pages.

Loading Paper

General Guidelines

The machine is designed to print on standard copier paper, but it can also accept a variety of other types of paper within the limits specified below.



Note The manufacturer assumes no liability for problems that occur when paper not satisfying these requirements is used.

Selection of the right paper is important. Using the wrong paper can result in paper jams, curling, poor print quality, and paper waste, and in extreme cases can damage the machine. The guidelines given below will increase the productivity of your office by ensuring efficient, trouble-free printing and reducing wear and tear on the machine.

Paper Availability

Most types of paper are compatible with a variety of machines. Paper intended for xerographic copiers can also be used with the machine.

There are three general grades of paper: economy, standard, and premium. The most significant difference between grades is the ease with which they pass through the machine. This is affected by the smoothness, size, and moisture content of the paper, and the way in which the paper is cut. The higher the grade of paper you use, the less risk there will be of paper jams and other problems, and the higher the level of quality your printed output will reflect.

Differences between paper from different suppliers can also affect the machine's performance. A high-quality machine cannot produce high-quality results when the wrong paper is used. Low-priced paper is not economical in the long run if it causes printing problems.

Paper in each grade is available in a range of basis weights (defined later). The traditional standard weights are 60 to 120 g/m² (16 to 31.9b).

Paper Specifications

The following table summarizes the basic paper specifications. Details are given on the following pages:

Item	Specifications
Weight	60 to 220 g/m ² (16 to 58.5 lb/ream)
Thickness	0.086 to 0.110 mm (3.4 to 4.3 mils)
Dimensional Accuracy	±0.7 mm (±0.0276 inches)
Squareness of Corners	90 ±0.2°
Moisture Content	4 to 6%
Pulp Content	80% or more

Minimum and Maximum Paper Sizes

The minimum and maximum paper sizes are as follows.

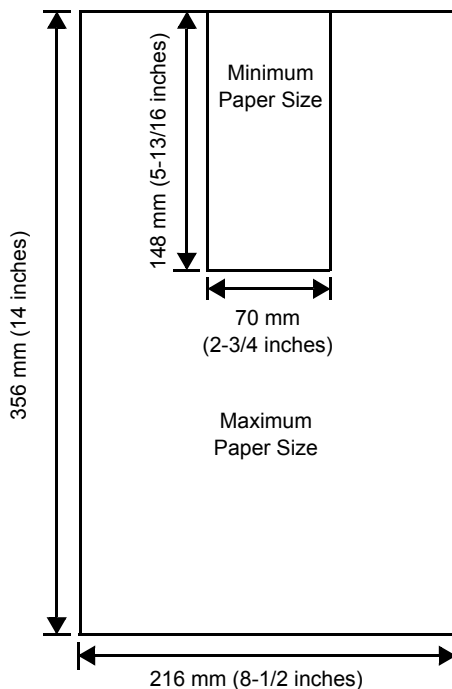

Selecting the Right Paper

This section describes the guidelines for selecting paper.

Condition

Avoid using paper that is bent at the edges, curled, dirty, torn, embossed, or contaminated with lint, clay, or paper shreds. Use of paper in these conditions can lead to illegible printing and paper jams, and can shorten the life of the machine. In particular, avoid using paper with a surface coating or other surface treatment. Paper should have as smooth and even a surface as possible.

Composition

Do not use paper that has been coated or surface-treated and contains plastic or carbon. The heat of fusing can cause such paper to give off harmful fumes.

Bond paper should contain at least 80% pulp. Not more than 20% of the total paper content should consist of cotton or other fibers.

Paper Sizes

Cassette is available for the paper sizes shown below. The dimensional tolerances are ± 0.7 mm for the length and width. The angle at the corners must be $90^\circ \pm 0.2^\circ$.

- A4 (210 × 297 mm)
- A5 (148 × 210 mm)
- A6 (105 × 148 mm)
- Folio (210 × 330 mm)
- JIS B5 (182 × 257 mm)
- ISO B5 (176 × 250 mm)
- Letter (8-1/2 × 11 inches)
- Legal (8-1/2 × 14 inches)
- Statement (5-1/2 × 8-1/2 inches)
- Executive (7-1/4 × 10-1/2 inches)

- Envelope Monarch (3-7/8 × 7-1/2 inches)
- Envelope #10 (4-1/8 × 9-1/2 inches)
- Envelope #9 (3-7/8 × 8-7/8 inches)
- Envelope #6-3/4 (3-5/8 × 6-1/2 inches)
- Envelope C5 (162 × 229 mm)
- Envelope DL (110 × 220 mm)
- Oficio II (216 × 340 mm, 8-1/2 × 13 inches)
- 216 × 340 mm
- 16 K (197 × 273 mm)
- Custom*
70 × 148 to 216 × 356 mm, 2-3/4 × 5-13/16 to 8-1/2 × 14 inches

* If the length of custom paper is larger than 297 mm (11-11/16 inches), the machine can be substituted A4, Folio, Legal, and Oficio II as the standard paper size.

Smoothness

The paper should have a smooth, uncoated surface. Paper with a rough or sandy surface can cause blank spaces in the printed output. Paper that is too smooth can cause multiple feeding and fogging problems. (Fogging is a gray background effect.)

Basis weight

Basis weight is the weight of paper expressed in grams per square meter (g/m²). Paper that is too heavy or too light may cause feed errors or paper jams as well as premature wear of the product. Uneven weight of paper, namely uneven paper thickness may cause multiple-sheet feeding or print quality problems such as blurring because of poor toner fusing.

The recommended basis weight is between 60 and 220 g/m² (16 to 58.5 lib/ream).

Paper Weight Equivalence Table

The paper weight is listed in pounds (lb) and metric grams per square meter (g/m²). The shaded part indicates the standard weight.

Europe Metric Weight (g/m ²)	U. S. Bond Weight (lb)	Europe Metric Weight (g/m ²)	U. S. Bond Weight (lb)
60	16	128	34
64	17	135	36
75	20	148	39
80	21	157	42
81	22	163	43
90	24	176	47
100	27	199	53
105	28	220	58.5
120	32		

Thickness

The paper used with the machine should be neither extremely thick nor extremely thin. If you are having problems with paper jams, multiple feeds, and faint printing, the paper you are using may be too thin. If you are having problems with paper jams and blurred printing the paper may be too thick. The correct thickness is 0.086 to 0.110 mm (3.4 to 4.3 mils).

Moisture Content

Moisture content is defined as the percent ratio of moisture to the dry mass of the paper. Moisture can affect the paper's appearance, feed ability, curl, electrostatic properties, and toner fusing characteristics.

The moisture content of the paper varies with the relative humidity in the room. When the relative humidity is high and the paper absorbs moisture, the paper edges expand, becoming wavy in appearance. When the relative humidity is low and the paper loses moisture, the edges shrink and tighten, and print contrast may suffer.

Wavy or tight edges can cause jams and alignment anomalies. The moisture content of the paper should be 4 to 6%.

To ensure correct moisture content, it is important to store the paper in a controlled environment. Some tips on moisture control are:

- Store paper in a cool, dry location.
- Keep the paper in its wrapping as long as possible. Re-wrap paper that is not in use.
- Store paper in its original carton. Place a pallet etc. under the carton to separate it from the floor.
- After removing paper from storage, let it stand in the same room as the machine for 48 hours before use.
- Avoid leaving paper where it is exposed to heat, sunlight, or damp.

Other Paper Properties

Porosity: Indicates the density of paper fiber.

Stiffness: Limp paper may buckle in the machine, resulting in paper jams.

Curl: Most paper naturally tends to curl one way if left unpacked. When paper passes through the fixing unit, it curls upward a little. To produce flat printouts, load the paper so that the upward pressure from the machine can correct their curling.

Electrostatic discharge: During the printing process the paper is electrostatically charged to attract the toner. The paper must be able to release this charge so that printed sheets do not cling together in the Output Tray.

Whiteness: The contrast of the printed page depends on the whiteness of the paper. Whiter paper provides a sharper, brighter appearance.

Quality control: Uneven sheet size, corners that are not square, ragged edges, welded (uncut) sheets, and crushed edges and corners can cause the machine to malfunction in various ways. A quality paper supplier should take considerable care to ensure that these problems do not occur.

Packaging: Paper should be packed in a sturdy carton to protect it from damage during transport. Quality paper obtained from a reputable supplier is usually correctly packaged.

Specially treated paper: We do not recommend printing onto the following types of paper, even if it conforms to the basic specifications. When you use these kinds of paper, purchase a small amount first as a sample to test.

- Glossy paper
- Watermarked paper
- Paper with an uneven surface
- Perforated paper

Special Paper

The following types of special paper can be used:

- Preprinted paper
- Labels*
- Bond paper
- Recycled paper
- Thin paper* (60 to 64 g/m²)
- Rough paper
- Letterhead
- Colored paper
- Prepunched paper
- Envelopes*
- Cardstocks (Postcards)*
- Thick paper (90 to 220 g/m²)
- High-quality paper

* Only one sheet can be loaded at a time in the cassette.

Use paper that is sold specifically for use with copiers or printers (heat-fusing type).

Since the composition and quality of special paper vary considerably, special paper is more likely than white bond paper to give trouble during printing. No liability will be assumed if moisture and so forth given off during printing on special paper causes harm to the machine or operator.



Note Before purchasing any type of special paper, test a sample on the machine and check that printing quality is satisfactory.

Labels

One label sheet can be loaded at a time.

The basic rule for printing on adhesive labels is that the adhesive must never come into contact with any part of the machine. Adhesive paper sticking to the drum or rollers will damage the machine.

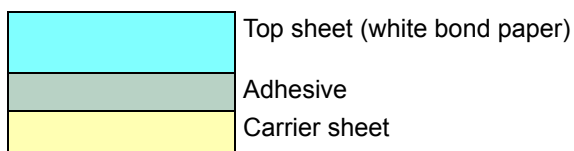

Label paper has a structure comprising of three layers, as shown in the diagram. The top sheet is printed on. The adhesive layer consists of pressure-sensitive adhesives. The carrier sheet (also called the linear or backing sheet) holds the labels until used. Due to the complexity of its composition, adhesive-backed label paper is particularly likely to give printing problems.

Adhesive label paper must be entirely covered by its top sheet, with no spaces between the individual labels. Labels with spaces in between are liable to peel off, causing serious paper jam problems.

Some label paper is manufactured with an extra margin of top sheet around the edge. Do not remove the extra top sheet from the carrier sheet until after printing is finished.

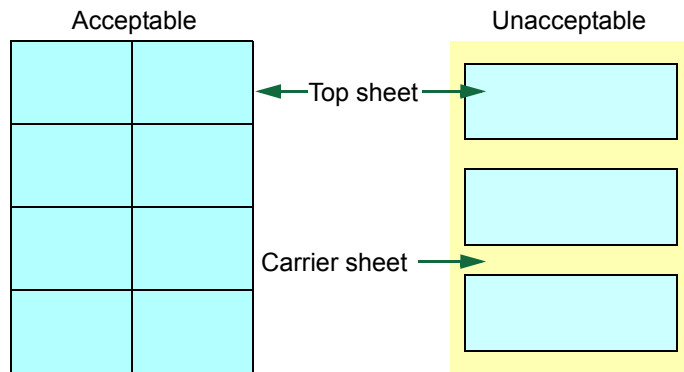

The table below lists the specifications for adhesive label paper.

Item	Specification
Weight of top sheet	44 to 74 g/m ² (12 to 20 lb/ream)
Composite weight	104 to 151 g/m ² (28 to 40 lb/ream)
Thickness of top sheet	0.086 to 0.107 mm (3.9 to 4.2 mils)
Composite thickness	0.115 to 0.145 mm (4.5 to 5.7 mils)
Moisture content	4 to 6% (composite)

Postcards

One postcard can be loaded at a time. Make sure the postcards you are going to set are not curled. Feeding curled postcards may cause paper jams.

Some postcards have rough edges on the back (those are created when the paper is cut). In this case, put the postcard on a flat place and rub the edges with, for example, a ruler to smooth them.

Envelopes

One envelope can be loaded at a time. Envelopes should be fed in the face-up position, right edge first.

Since the composition of an envelope is more complex than that of ordinary paper, it is not always possible to ensure consistent printing quality over the entire envelope surface.

Normally, envelopes have a diagonal grain direction. This direction can easily cause wrinkles and creases when envelopes pass through the machine. Before purchasing envelopes, make a test print to check whether the machine accepts the envelope.

- Do not use envelopes that have an encapsulated liquid adhesive.
- Avoid a long printing session for envelopes only. Extended envelope printing can cause premature machine wear.

Thick Paper

If an excessive amount of thick paper is loaded in the cassette, it may not be fed. In that case, reduce the number of sheets to be loaded.

Fan the stack of paper and align the edges before loading them in the paper source. Some types of paper have rough edges on the back (those are created when the paper is cut). In this case, put the paper on a flat place and rub the edges once or twice with, for example, a ruler to smooth them. Feeding rough edged paper may cause paper jams.

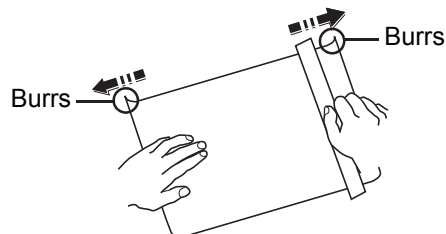

Note If paper is not fed even after its rough edges have been removed, warp the paper at the leading edge upward for a few millimeters as shown in the figure, and then load the paper.

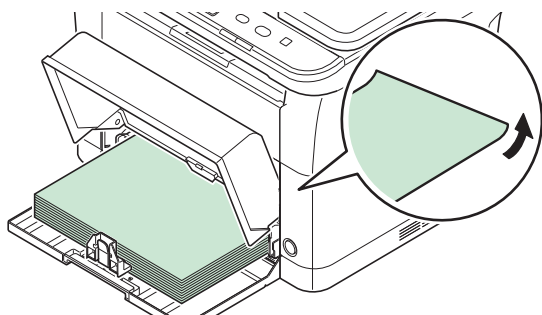

Colored Paper

Colored paper should satisfy the same conditions as white bond paper. Refer to *Paper Specifications* on page 2-4. In addition, the pigments used in the paper must be able to withstand the heat of fusing during the printing process (up to 200°C or 392°F).

Preprinted Paper

Preprinted paper should satisfy the same conditions as white bond paper. Refer to *Paper Specifications* on page 2-4. The preprinted ink must be able to withstand the heat of fusing during the printing process, and must not be affected by silicone oil.

Do not use paper with any kind of surface treatment, such as the type of paper commonly used for calendars.

Recycled Paper

Select recycled paper that meets the same specifications as the white bond paper except for whiteness. Refer to *Paper Specifications* on page 2-4.

Note Before purchasing recycled paper, test a sample on the machine and check that the printing quality is satisfactory.

Paper Type

The machine is capable of printing under the optimum setting for the type of paper being used.

Not only can preset paper types be selected, but it is also possible for you to define and select customized paper types. Paper type can be changed using the printer driver and KYOCERA Client Tool. The following types of paper can be used.

Paper Type	Paper Weight Displayed in KYOCERA Client Tool	Paper Type	Paper Weight Displayed in KYOCERA Client Tool
Plain	Normal 2	Color	Normal 2
Preprinted	Normal 2	Prepunched	Normal 2
Labels*	Heavy 1	Envelope*	Heavy 2
Bond	Heavy 1	Cardstock*	Heavy 2
Recycled	Normal 2	Thick	Heavy 2
Vellum*	Light	High quality	Normal 2
Rough	Heavy 1	Custom 1 (to 8)**	Normal 2
Letterhead	Normal 2		

* One sheet must be loaded at a time.

** This is a paper type defined and registered by the user. Up to eight types of user settings may be defined. For more information, refer to *KYOCERA Client Tool User Guide*.

Preparing the Paper

After removing paper from the packaging, fan through the sheets to separate them prior to loading.

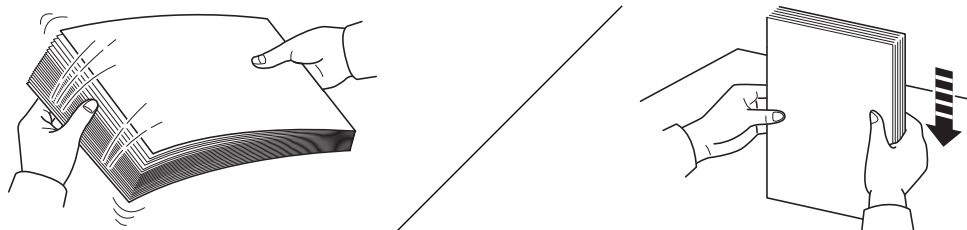

If using paper that has been folded or is curled, straighten it prior to loading. Failure to do so may result in a paper jam.

IMPORTANT Ensure paper is not stapled and clips are removed.

You should not use inkjet printer paper or any paper with a special surface coating. (Such papers may cause paper jams or other faults.)

Loading Paper into Cassette

250 sheets of A4 or Letter paper (80 g/m²) may be loaded into the cassette.

- 1 Open the cassette cover.

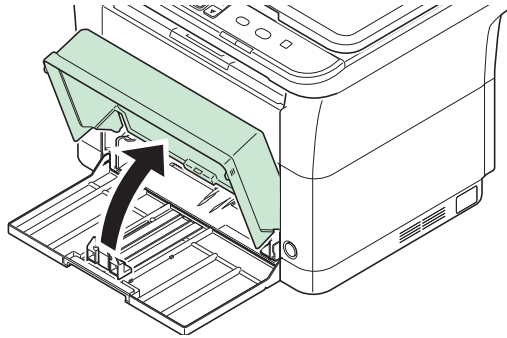

 **Note** When using paper that is larger than A4/Letter, remove the cassette cover. Gently press on both the left and right sides of the cassette cover and pull.

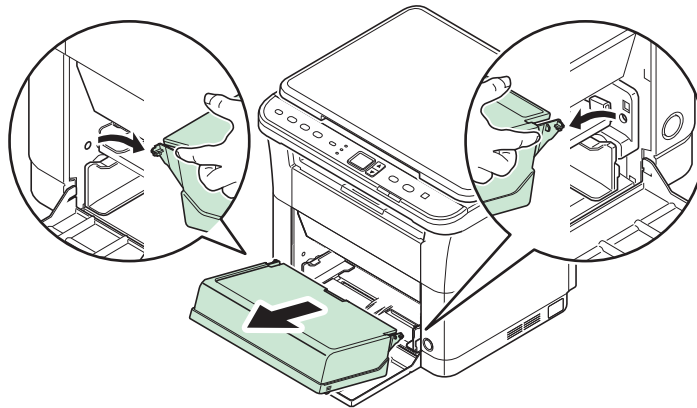

If necessary, open the paper stopper shown in the figure.

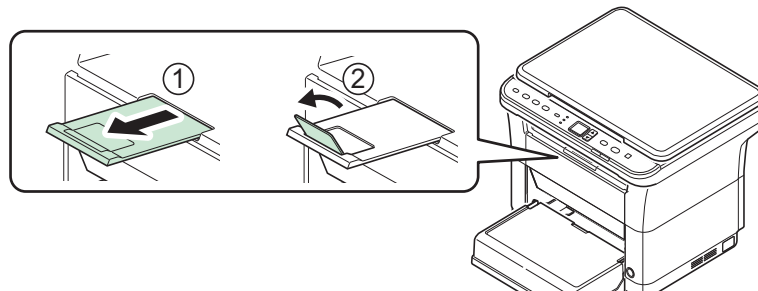

- 2 Adjust the position of the width guides located on the left and right sides of the cassette.

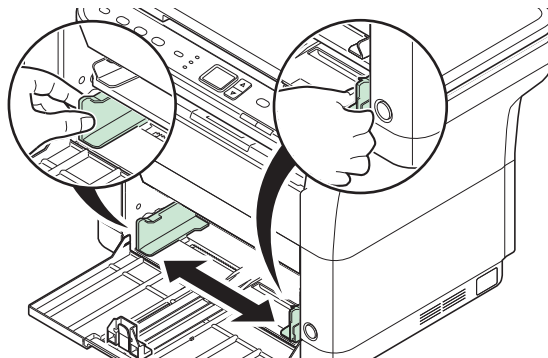

 **Note** Paper sizes are marked on the cassette.

- 3 Adjust the paper length guide to the paper size required.

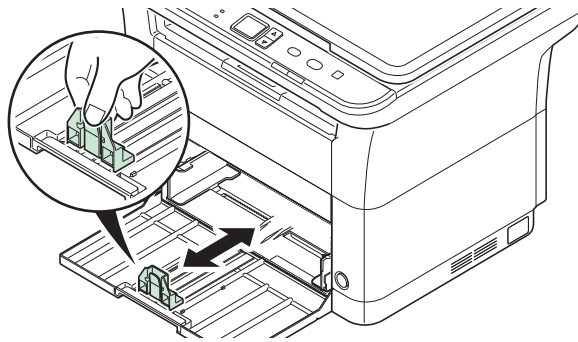

Note When using paper larger than A4/Letter, pull out the paper length guide.

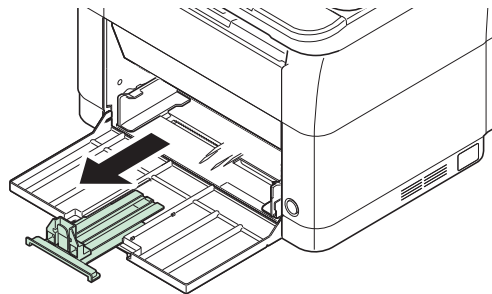

When using A6 paper, attach the stopper.

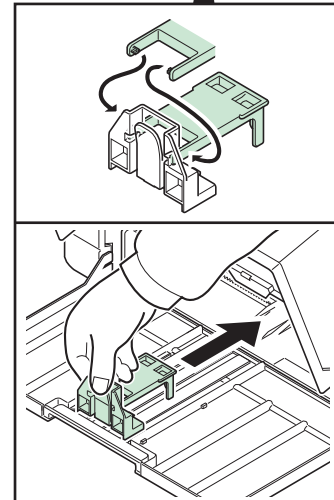
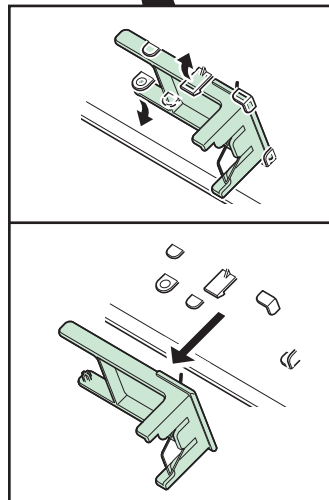
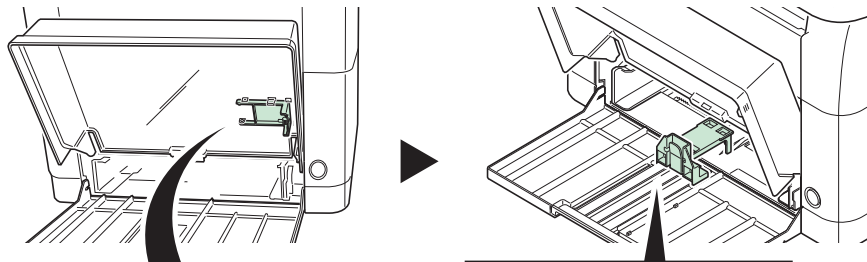

Move the stopper to the A6 position.

- 4 Load the paper all the way in the cassette until the paper touches the far inner side. Ensure the side to be printed is facing up and the paper is not folded, curled, or damaged.

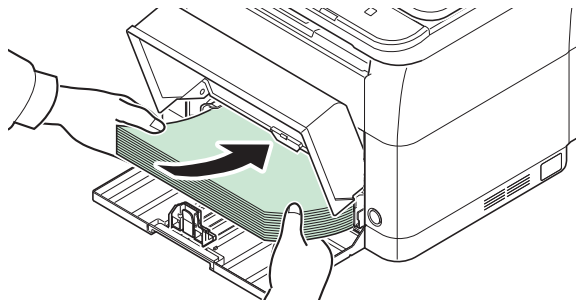

IMPORTANT Adjust so that there is no gap between the paper length guide and the paper.

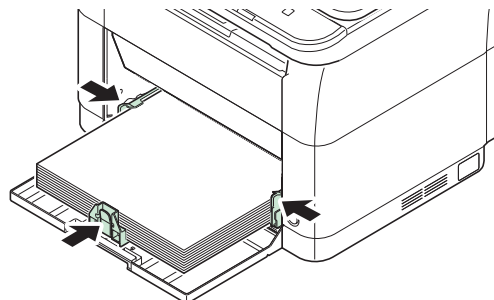

Note Load an amount of paper that fits under (does not contact) the tabs on the width guides.

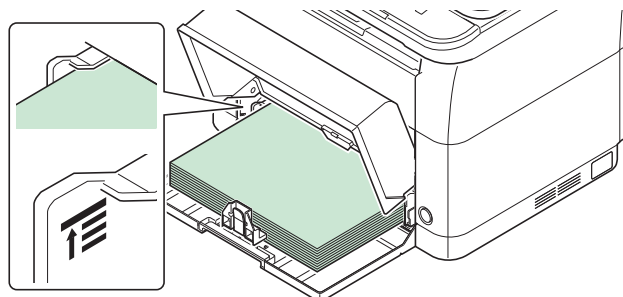

When using A6 paper, load the paper as shown in the illustration.

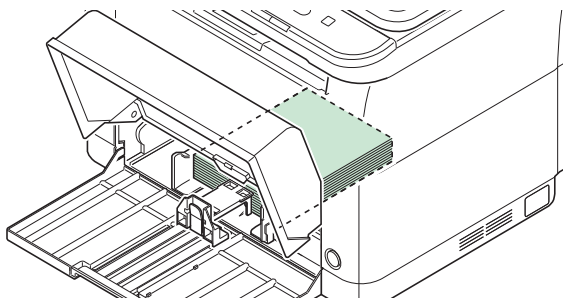

When loading an envelope, load as shown in the illustration.

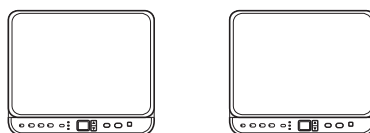

Close the flap.

Correct

Incorrect

Load envelope with the print side facing up.

- 5** Close the cassette cover.

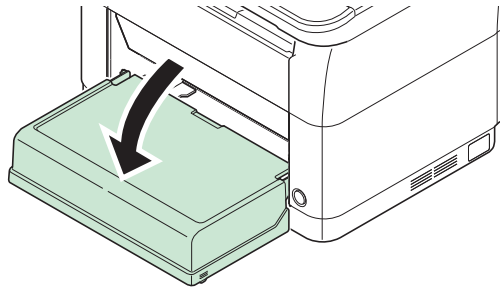

 **Note** When storing the cassette, or when using paper larger than A4/Letter, remove the cassette cover.

- 6** Specify the paper size and type for the cassette using KYOCERA Client Tool. For more information, refer to *Configuration* on page 2-36.

 **Note** Set the same paper size to the paper size that is set on the machine.

When you attach the cassette cover

Attach the cassette cover as shown.

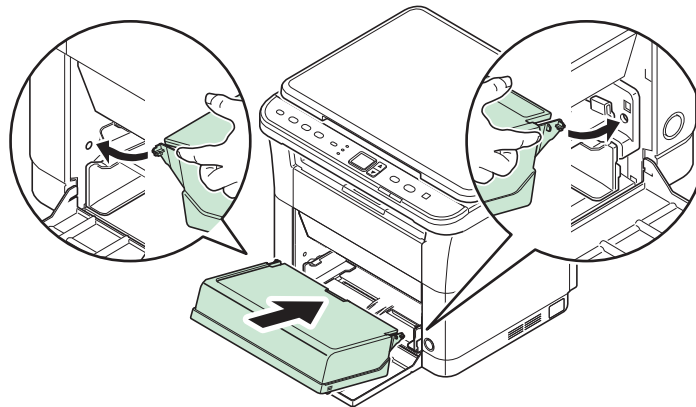

Loading Originals

You may place books or magazines on the platen in addition to ordinary sheet originals.



Note Shadows may be produced around the edges and in the middle of open-faced originals.

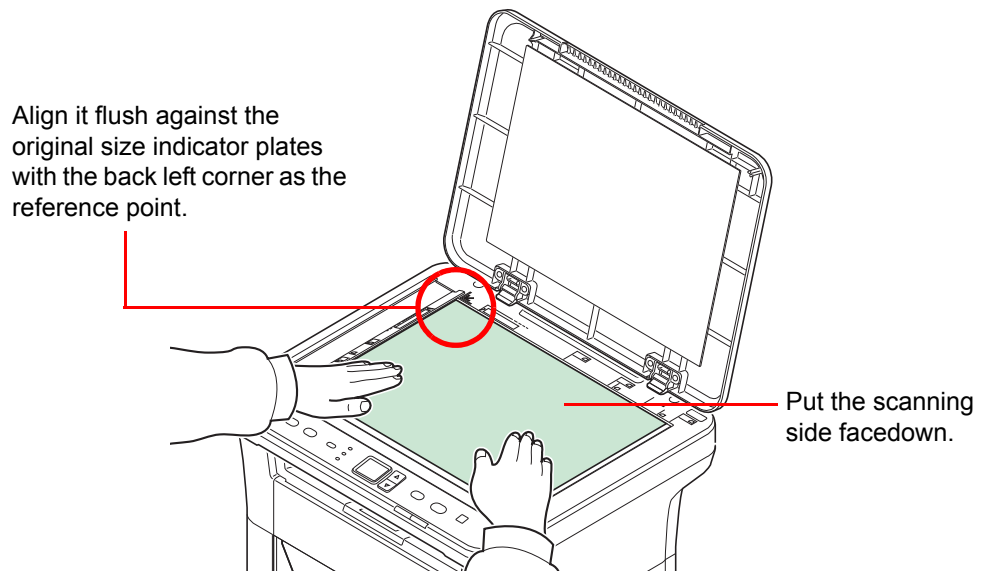

Open the original cover, and place the original.

IMPORTANT Do not push the original cover forcefully when you close it. Excessive pressure may crack the platen. (Allowable load weight: 5 kg or less)

When placing books or magazines on the machine, do so with the original cover in the open position.

Installing and Uninstalling Drivers and Utilities

This section explains how to configure machine settings and install the software required for use as a machine. Ensure the machine is plugged in and connected to the PC before installing the software from the *Product Library* disc.



Note Install the software when the machine status is online*.

* 01 (in copy mode) or P0 (in scan or Print Box mode) appears in the operation panel display.

Software

The following software can be installed from the provided *Product Library* disc.

●: Installed standard. ○: Installed if selected.

Software	Function	Description	Installation Method		Reference Page
			Express Install	Custom Install	
GX DRIVER	Print	Driver for printing files on a computer using the machine. This printer driver enables full use of the machine's features.	●	○	<i>Printer Driver User Guide</i>
GX XPS DRIVER		Printer driver for XPS (XML Paper Specification) format developed by Microsoft Corporation.	—	○	
TWAIN Driver	Scan	Driver for scanning on the machine using a TWAIN-compatible software application.	●	○	5-5
WIA Driver		WIA (Windows Imaging Acquisition) is a function of Windows that enables reciprocal communication between an imaging device such as a scanner and an image processing software application. An image can be acquired using a WIA-compliant software application, which is convenient when a TWAIN-compliant software application is not installed in the computer.	●	○	5-5
KYOCERA Net Viewer	Utility	Utility that enables the machine to be monitored when connected to a network.	—	○	<i>KYOCERA Net Viewer User Guide</i>
KYOCERA Client Tool		Utility that enables current and all supported devices status, features and settings to be accessed. When KYOCERA Client Tool is installed, the following utilities are installed. <ul style="list-style-type: none"> • Status Monitor (page 2-27) • Preset Tool (page 2-28) • Configuration (page 2-36) • Maintenance Menu (page 6-7) 	●	○	2-22

Installing the Software in Windows

If you are connecting this machine to a Windows PC, follow the next steps to install the software. The example shows you how to connect your machine to a Windows 7.

 **Note** In Windows operating systems, you must be logged in with administrator privileges to install the software.

You can use either Express Install or Custom Install to install the software. Express Install automatically detects connected machines and installs the required software. Use Custom Install if you want to specify the printer port and select the software to be installed.

- 1 Turn on the computer and start up Windows.
If the Welcome to the **Found New Hardware Wizard** screen displays, select **Cancel**.
- 2 Insert the *Product Library* disc supplied with the machine into the optical drive. In Windows 7, Windows Server 2008 and Windows Vista, the user account control window may appear. Click **Yes**.

The installation program launches.

 **Note** If the software install wizard does not launch automatically, open the *Product Library* disc window in Windows Explorer and double-click **Setup.exe**.

- 3 Click **View License Agreement** and read the License Agreement. Click **Accept**.

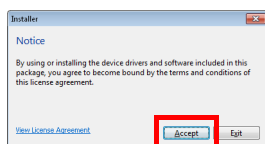

The software install wizard starts up.

From this point, the procedure differs depending on your version of Windows and your connection method. Proceed to the correct procedure for your connection type.

- Express Install
- Custom Install

Express Install

In Express Install, the installer automatically detects the machine when it is turned on. Use Express Install for standard connection methods.

- 1 Select the **Express Install** tab. The installer detects the machine.

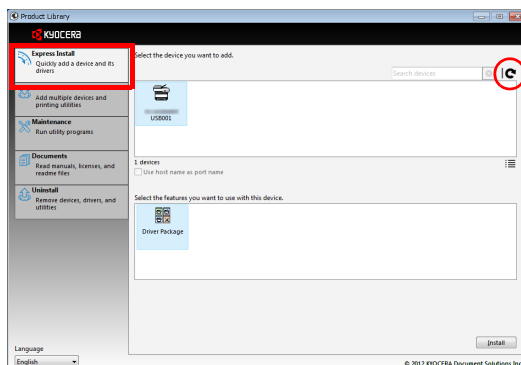

If the installer does not detect a print system, check that the print system is connected via USB and that it is turned on. Then click **Refresh** to search print system again.

 **Note** While the information shown in Windows 7 and Windows Vista/Windows XP installation dialog boxes differs slightly, the installation procedure is the same.

- 2 Select the machine you want to install, select the **Driver Package**, and click **Install**.

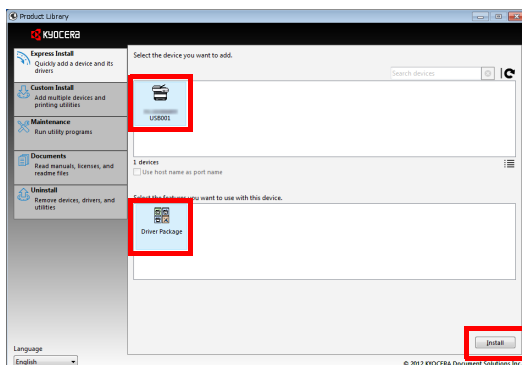

Note If the Found New Hardware Wizard appears, click **Cancel**. If a hardware installation warning message appears, click **Continue**.

If the Windows security window appears, click **Install this driver software anyway**.

- 3 A message appears saying that your software is ready to use. To print a test page, select the **Print a test page** checkbox and select the machine.

Click **Finish** to exit the installation wizard.

This completes the software installation procedure.

Custom Install

Use Custom Install if you want to specify the printer port and select the software to be installed.

- 1 Select **Custom Install** tab.

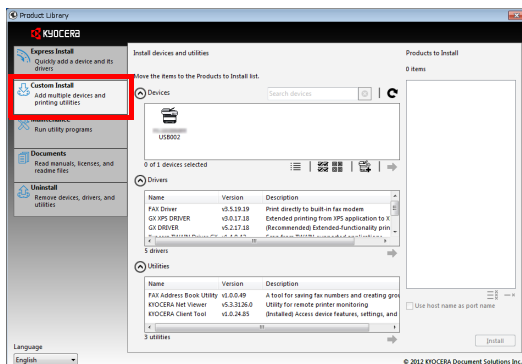

- 2 Select the device to be installed, and click the arrow button to move it to the **Products to Install** list.
- 3 Select the software to be installed, and click the arrow button to move it to the **Products to Install** list.
- 4 Click **Install**.
- 5 A message appears saying that your software is ready to use. To print a test page, select the **Print a test page** checkbox and select the machine.

Click **Finish** to exit the installation wizard.

This completes the software installation procedure.

Installation on a Macintosh

This section explains how to install the printer driver in Mac OS.

- 1 Turn on the machine and the Macintosh.
- 2 Insert the *Product Library* disc supplied with the machine into the optical drive.
- 3 Double-click the *Product Library* disc icon.

4 Double-click **OS X 10.5 or higher**.



5 Double-click **Kyocera OS X 10.5+ xxxxx**.



6 The printer driver installation program starts up.



7 Install the printer driver as directed by the instructions in the installation software.

IMPORTANT In the Authentication screen, enter the name and password used to log in to the operating system.

This completes the printer driver installation.

Uninstalling Drivers and Utilities

The software can be uninstalled (removed) using the *Product Library* disc supplied with the machine.

IMPORTANT On Macintosh computers, because the machine settings are specified using a PPD (PostScript Printer Description) file, the software cannot be uninstalled using the *Product Library* disc.



Note When KYOCERA Net Viewer is installed, separate uninstallers are launched for this application. Proceed with the uninstallation steps for this application as directed by the on-screen instructions.

- 1 Exit all active software applications.
- 2 Insert the *Product Library* disc supplied with the machine into the optical drive. In Windows 7, Windows Server 2008 and Windows Vista, the user account control window may appear. Click **Yes**.
- 3 Following the procedure used to install the software, click **Uninstall** tab.

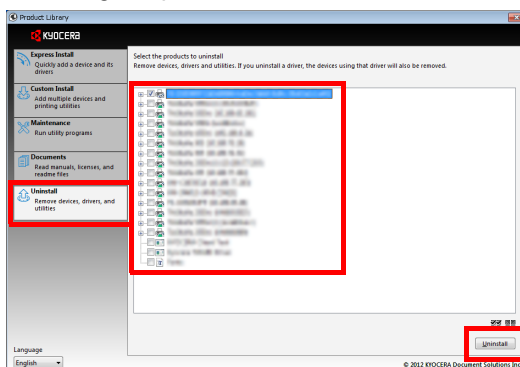

- 4 Select the software package to remove.
- 5 Click **Uninstall**.
The uninstaller starts.
- 6 When Uninstall complete screen appears, click **Finish**.
- 7 If Restart Your System screen appears, select whether you restart your computer or not, and click **Finish**.

Machine Settings

Various machine settings can be configured from a computer using KYOCERA Client Tool. Install KYOCERA Client Tool from the provided *Product Library* disc.



Note For the detailed functions of KYOCERA Client Tool, refer to *KYOCERA Client Tool User Guide*.

Accessing KYOCERA Client Tool

Start KYOCERA Client Tool.



KYOCERA Client Tool Functions

The functions of KYOCERA Client Tool are described below.

Function	Description	Reference Page
KYOCERA Client Tool	KYOCERA Client Tool gives you quick access to common machine features and settings, plus the current status of all supported machines. You can also use KYOCERA Client Tool to order toner, download printer drivers, access KYOCERA Net Viewer, open the company website and view machine documentation.	2-23
Status Monitor	Lets you view the status of the machine on your desktop.	2-27
Preset Tool	Registers the Copy, Scan and Print Box programs.	2-28
Configuration	Allows user to configure machine settings, including energy saving and paper settings. Messages shown in the Status Monitor are also configured here.	2-36
Maintenance Menu	For machine maintenance. Use when print quality deteriorates or to adjust the print or scan position.	6-7

KYOCERA Client Tool Settings

General

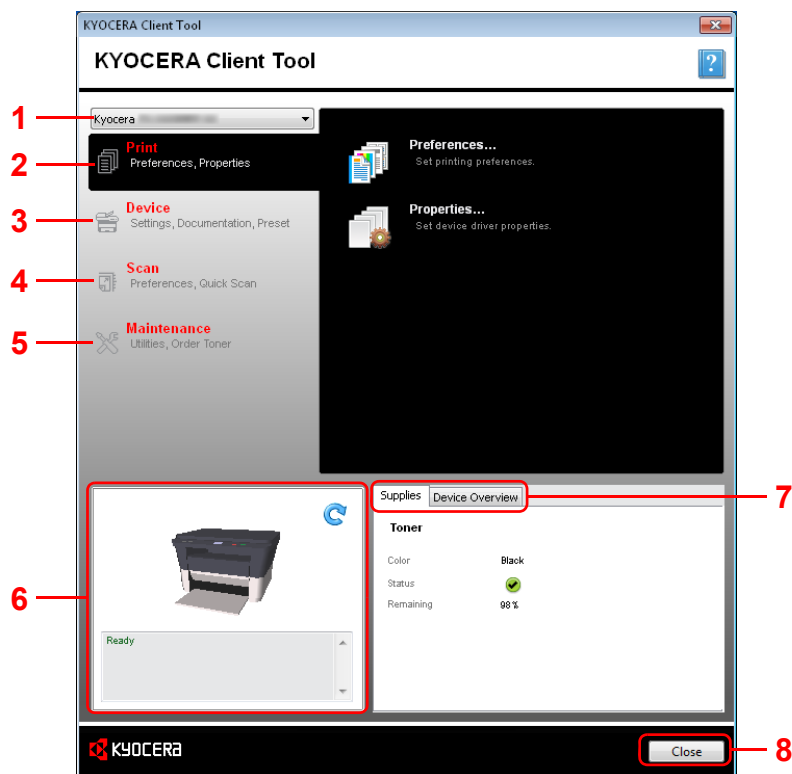

No.	Item	Description	Reference Page
1	Machine list	The list at the top of KYOCERA Client Tool screen includes all of the supported machines installed on your computer. You can select a machine from this list to view its properties and select available options, such as configuration, maintenance, and driver download.	—
2	Print	The Print tab gives you access to printing preferences and machine driver properties. Click Preferences or Properties to open the settings.	2-24
3	Device	The Device tab lets you configure a machine, view documentation, restart a machine and restore factory default settings. Click Configuration to display the Configuration screen. This lets you configure various machine settings. Refer to <i>Configuration</i> on page 2-36.	2-25
4	Scan	The Scan tab lets you configure TWAIN and Quick Scan settings. Scan to PDF, Scan to Email and Scan to Folder can also be executed from this tab.	2-25

No.	Item	Description	Reference Page
5	Maintenance	The Maintenance tab lets you open KYOCERA Net Viewer*, order replacement toner, view our web site, and download software. Click Maintenance Menu to display the Maintenance Menu screen. This lets you perform machine maintenance. Refer to <i>Maintenance Menu</i> on page 6-7.	2-26
6	Machine status	This shows a 3D image of the selected machine and its current status. Click  (Refresh) to refresh the machine status.	—
7	Supplies	The Supplies tab shows the toner status.	—
	Device Overview	The Device Overview tab shows the machine settings.	—
8	Close	Clicking Close exits KYOCERA Client Tool.	—

* To display **KYOCERA Net Viewer**, KYOCERA Net Viewer must be installed.

Print Tab

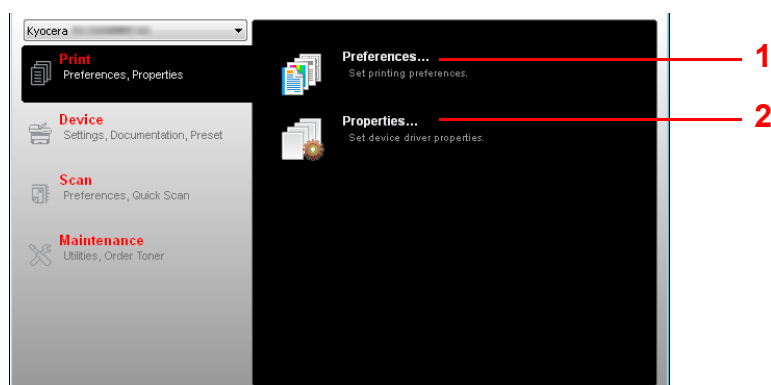

No.	Item	Description
1	Preferences	Opens the Printing Preferences screen for the selected machine.
2	Properties	Opens the Properties screen for the selected machine.

Device Tab

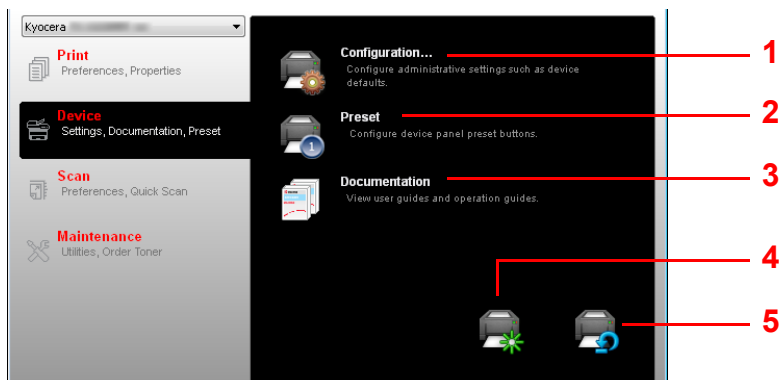

No.	Item	Description	Reference Page
1	Configuration	Opens the Configuration screen for the selected machine.	2-36
2	Preset	Opens the Preset Tool screen for the selected machine.	2-28
3	Documentation	Opens the folder where manuals are contained.	—
4	Device restart	Click the Device restart icon to restart the machine. Click Yes to confirm. You must be logged in with administrator privileges on your PC.	—
5	Factory default	Click the Factory default icon to return all of the machine properties of the selected model to its default settings. Click OK to confirm. You must be logged in with administrator privileges on your PC.	—

Scan Tab

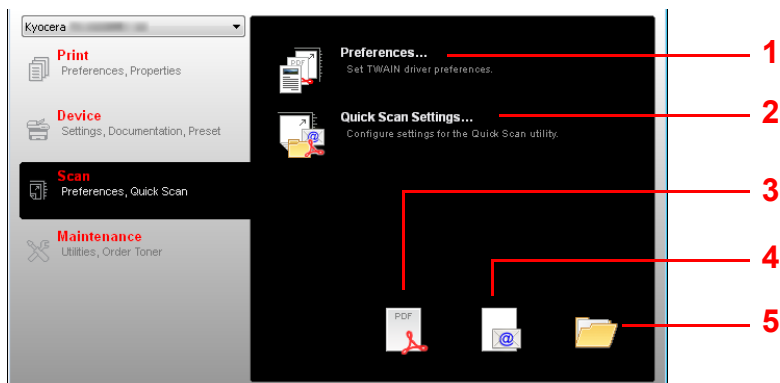

No.	Item	Description	Reference Page
1	Preferences	Opens TWAIN screen. Set the default value for the TWAIN scan.	2-34
2	Quick Scan Settings	Opens Quick Scan screen.	2-34
3	Scan to PDF	Saves the scanned image in PDF format.	5-4
4	Scan to Email	Attaches the scanned image to a new E-mail message.	5-4
5	Scan to Folder	Saves the scanned image to a specified folder.	5-4

Maintenance Tab

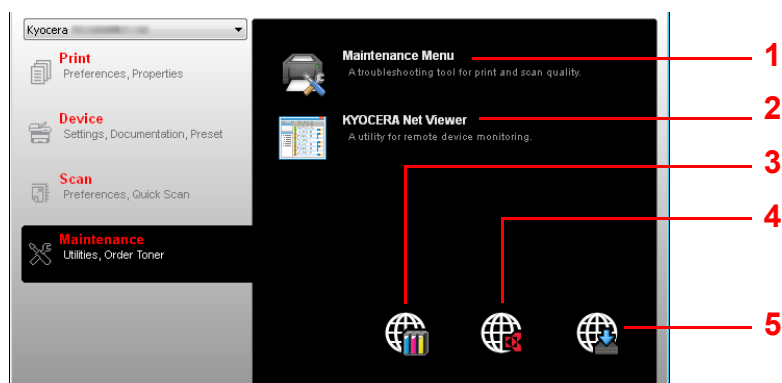

No.	Item	Description	Reference Page
1	Maintenance Menu	Opens Maintenance Menu screen.	6-7
2	KYOCERA Net Viewer	Opens KYOCERA Net Viewer.*	<i>KYOCERA Net Viewer User Guide</i>
3	Order Toner	You can order replacement toner by e-mail or on the web. Click the Order Toner icon for these options: <ul style="list-style-type: none"> Send e-mail Use the default e-mail address or type another e-mail address and then click OK to open your default e-mail program. Open Web page Use the default web address or type another web address and then click OK to open the web page in your default web browser. 	—
4	Kyocera Online	Opens our website.	—
5	Driver Download	Click to open the download page of our website. You can download software and find an authorized dealer.	—

* To display **KYOCERA Net Viewer**, KYOCERA Net Viewer must be installed.

Status Monitor

When KYOCERA Client Tool is installed, you can check the machine status in the Status Monitor icon.

The Status Monitor icon displays machine status messages in the lower right corner of the screen.

Screen Overview

The screen overview of the Status Monitor icon is as follows.

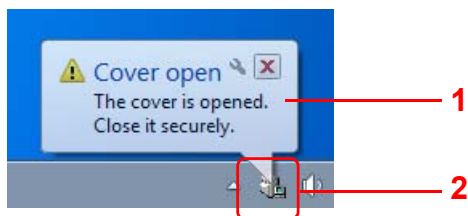

No.	Item	Description
1	Pop-up window	If an information notification event occurs, a pop-up window appears. Information notification events can be set in the Configuration. Refer to <i>Configuration</i> on page 2-36.
2	Status Monitor icon	The Status Monitor icon is displayed in the taskbar notification area when the Status Monitor is running.

When the Status Monitor icon is active, you can select KYOCERA Client Tool options by right-clicking the icon in the system tray.

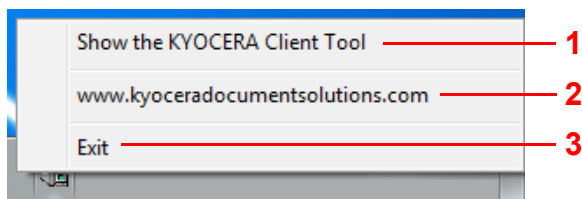

No.	Item	Description
1	Show/Hide the KYOCERA Client Tool	Switches between hiding and showing KYOCERA Client Tool screen.
2	(URL)	Opens our website.
3	Exit	Closes KYOCERA Client Tool and removes the Status Monitor icon from the system tray.

Default and Program Settings

This section explains about the Copy, Print Box, and Scan default settings and programs. For settings that are frequently changed from the default settings, it is convenient to register a program.

Default Settings

This section explains the default settings for each function.

Functions	Description
Copy	The default settings for Copy are changed with the Configuration. For details, refer to <i>Configuration</i> on page 2-36.
Print Box	It is not possible to change the default settings for Print Box. The job stored in the Default folder is printed. The Program is used to select the Print Box. Refer to <i>Program Settings</i> on page 2-28.
Push Scan	It is not possible to change the default settings for Push Scan. The Program is used to change the settings. Refer to <i>Program Settings</i> on page 2-28.

Program Settings

If you have settings that are frequently changed from the default settings, register the settings in a program. You can simply select the program number as needed to recall those functions.

Programs can be registered from a computer using Preset Tool. The Preset Tool is a function of KYOCERA Client Tool. Three programs can be registered per function.

This section explains how to register a program. To use a registered program, refer to the pages of each function.

- Copy: *Basic Operation* on page 3-2
- Scan: *Push Scan* on page 5-2
- Print Box: *Printing from Print Box* on page 4-6

Accessing the Preset Tool

- 1 Start KYOCERA Client Tool as explained in *Accessing KYOCERA Client Tool* on page 2-22.
- 2 Click **Preset** on the **Device** tab. The Preset Tool opens.

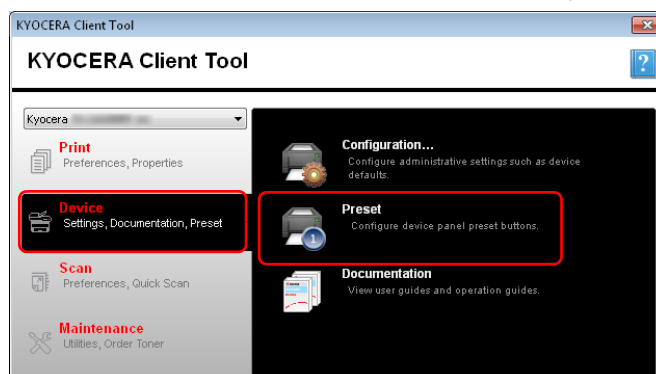



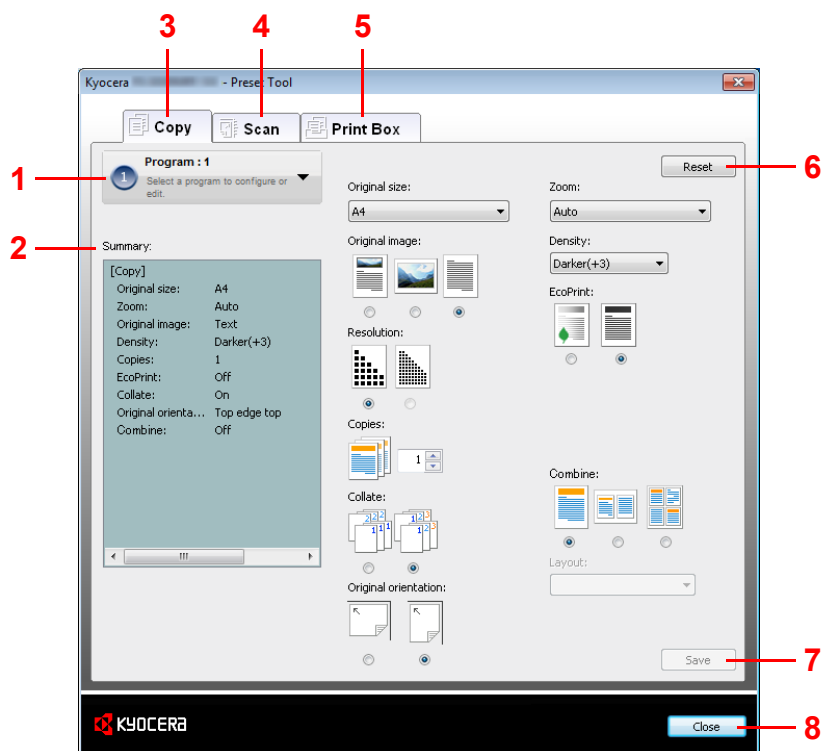





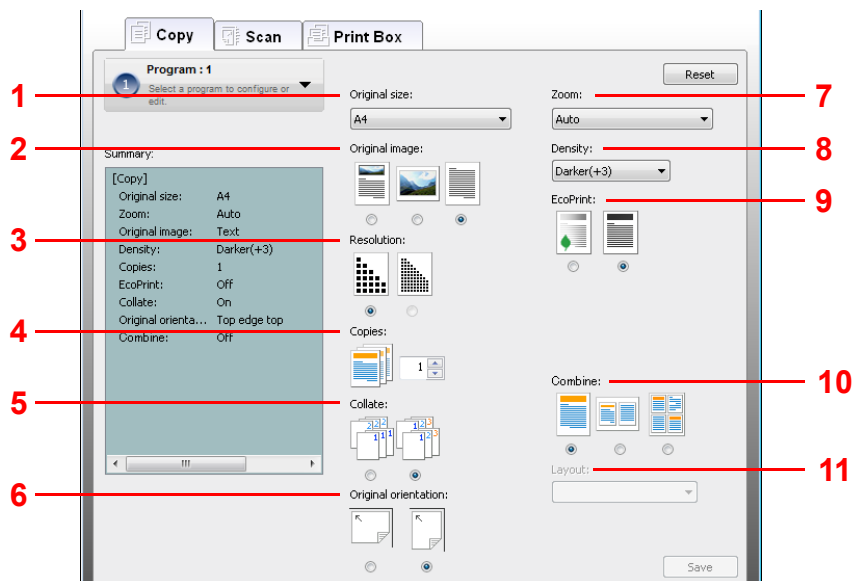

General











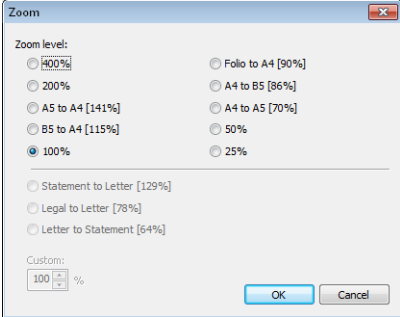
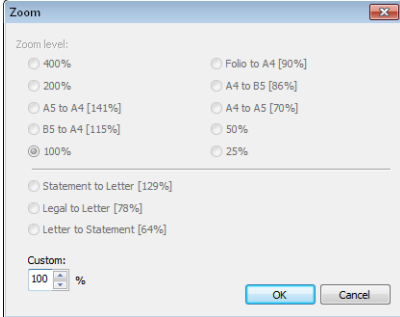

No.	Item	Description	Reference Page
1	Program number	Select the program number (1 to 3) to be registered. When a program number is selected, the settings registered in that number appear in the right-hand screen.	—
2	Summary	Shows a list of the settings of the selected program.	—
3	Copy	Set programs for the Copy function.	2-30
4	Scan	Set programs for the Scan function.	2-32
5	Print Box	Set programs for the Print Box function.	2-33
6	Reset	Reset the program to default values.	—
7	Save	Save your settings.	—
8	Close	Close the Preset Tool.	—

Copy Tab

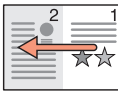

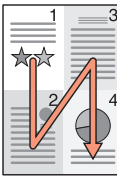

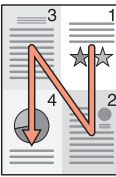



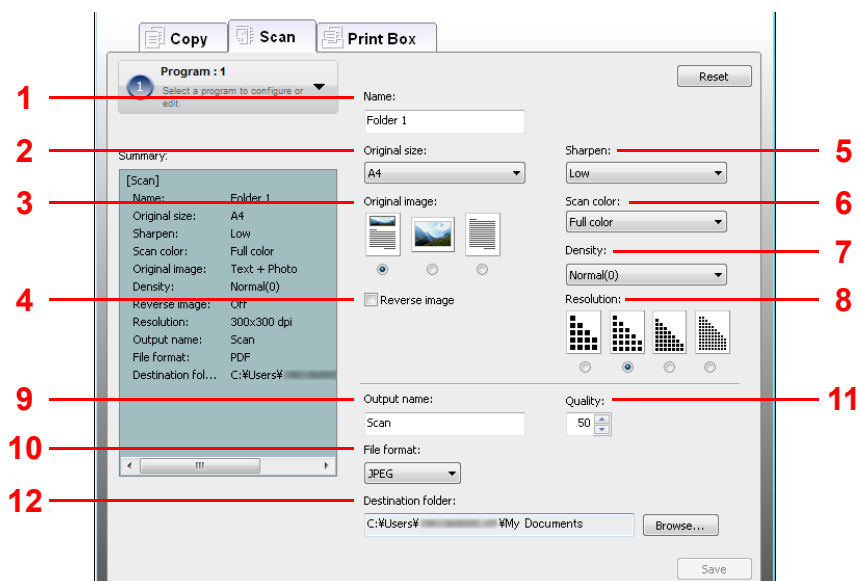

No.	Item	Description
1	Original size	Specify the size of originals being scanned. Value: Executive, Letter, A4, A5, A6, B5 (JIS), B5 (ISO), Custom, 16K, Statement Note Refer to <i>Configuration</i> on page 2-36 for selecting Custom .
2	Original image	Select image quality suited to the type of original. Value:    Text + Photo Photo Text
3	Resolution	The resolution is selected when Text + Photo is selected in Original image . Select 600 dpi when you want good reproduction of fine text and lines in originals which contain a mixture of text and photos. Value:   300 dpi 600 dpi Note The Photo and Text selections in Original image are fixed at 300 dpi .
4	Copies*	Set the default value for the number of copies. Value: 1 to 99
5	Collate	Scan multiple originals and deliver complete sets of copies as required according to page number. Value:   Off On
6	Original orientation	Select the orientation of the original document top edge to scan correct direction. Value:   Top Edge Left Top Edge Top

No.	Item	Description
7	Zoom	<p>Adjust the magnification to reduce or enlarge the original image. Value: 100%, Auto, Custom, Fixed When Custom or Fixed is selected, the Zoom screen is displayed.</p> <div style="display: flex; justify-content: space-around;"> <div style="text-align: center;">  <p>Zoom level (Fixed) Adjusts the image to match present sizes.</p> </div> <div style="text-align: center;">  <p>Custom* Specify the image size in 1% increment between 25% - 400% of the original.</p> </div> </div>
8	Density	Adjust density using 7 levels. Value: Lighter (-3), Lighter (-2), Lighter (-1), Normal (0), Darker (+1), Darker (+2), Darker (+3)
9	EcoPrint	Use EcoPrint to save toner when printing. Use this function for test copies or any other occasion when high quality print is not required. Value:  On  Off
10	Combine	Combine 2 or 4 original sheets into 1 copied page. Value:  Off  2in1  4in1
11	Layout	You can select the page layout. Value: 2in1 4in1  Left to right  Right to left  Right then down  Down then right  Left then down  Down then left

* Non-numeric characters cannot be entered. If entered number is beyond range, the max/min value will be restored.

Scan Tab



No.	Item	Description
1	Name	Set a name for the Program. Up to 18 characters can be entered.
2	Original size	Specify the size of originals being scanned. Value: Executive, Letter, A4, A5, A6, B5 (JIS), B5 (ISO), Custom, 16K, Statement Note Refer to <i>Configuration</i> on page 2-36 for selecting Custom .
3	Original image	Select image quality suited to the type of original. Value:    Text + Photo Photo Text
4	Reverse image	When this is selected, the image color reverses.
5	Sharpen	Adjust the sharpness of the image. Value: None, Low, Medium, High, Descreen (Blurs the outlines and reduces the sharpness.)
6	Scan color	Select the color mode setting. Value: Monochrome, Grayscale, Full color
7	Density	Select the density. Value: Lighter (-3), Lighter (-2), Lighter (-1), Normal (0), Darker (+1), Darker (+2), Darker (+3)
8	Resolution	Select fineness of scanning resolution. Value:     200×200 dpi 300×300 dpi 400×400 dpi 600×600 dpi
9	Output name	Assign a document name to scanned images. When there are multiple pages, a three-digit incrementing number such as Scan_001, Scan_002... is appended to the end of the file name. Up to 16 characters can be entered.
10	File format	Specify the image file format. Value: BMP, JPEG, PNG, TIFF, PDF

No.	Item	Description
11	Quality	Set the quality if file format is JPEG. This is disabled for non-JPEG format. Value: 1 to 100 Note Non-numeric characters cannot be entered. If entered number is beyond range, the max/min value will be restored.
12	Destination folder	Enter the path of the folder where the scanned image will be saved. Either C:\User\ <user>\my (on="" 7)="" and="" as="" c:\document="" default.<br="" documents="" is="" or="" set="" settings\<user>\my="" the="" vista="" windows="" xp)=""></user>\my> Enter the path of the folder where the scanned image will be saved. To select the folder, click Browse to open Browse for Folder .

Print Box Tab

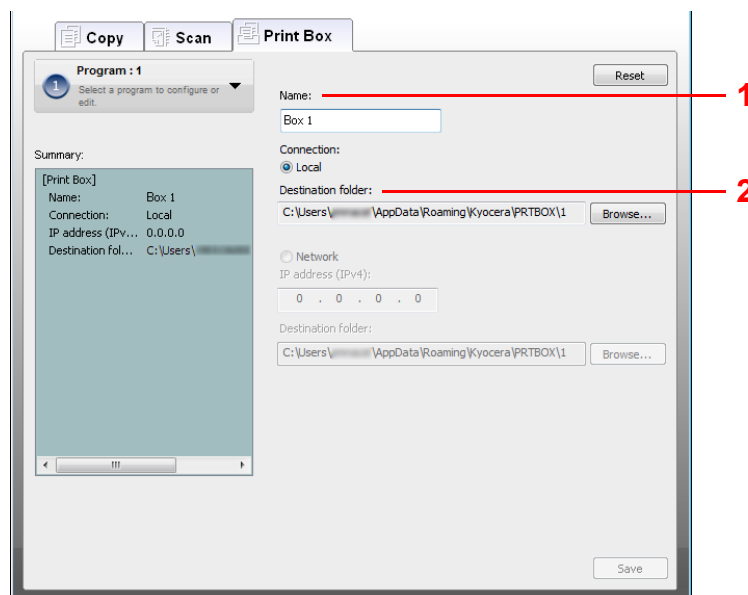

No.	Item	Description
1	Name	Set a name for the Program. Up to 18 characters can be entered.
2	Destination folder	Enter the path for the folder to be used as the Print Box. Program 1 is Box 1, Program 2 is Box 2 and Program 3 is Box 3. To select the folder, click Browse to open Browse for Folder .

Quick Scan/TWAIN Settings

Settings required for scanning on the machine are explained below. The settings specified here will be the default settings for scanning.

Item	Description
Preferences	Change the TWAIN scan settings. This setting is effective for Quick Scan only.
Quick Scan Settings	Change the settings for Scan to PDF, Scan to Email and Scan to Folder.

- 1 Start KYOCERA Client Tool as explained in *Accessing KYOCERA Client Tool* on page 2-22.
- 2 Click **Preferences** or **Quick Scan Settings** on the **Scan** tab.

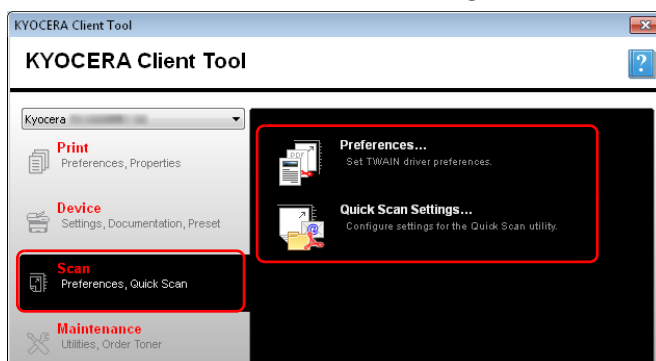

TWAIN Settings

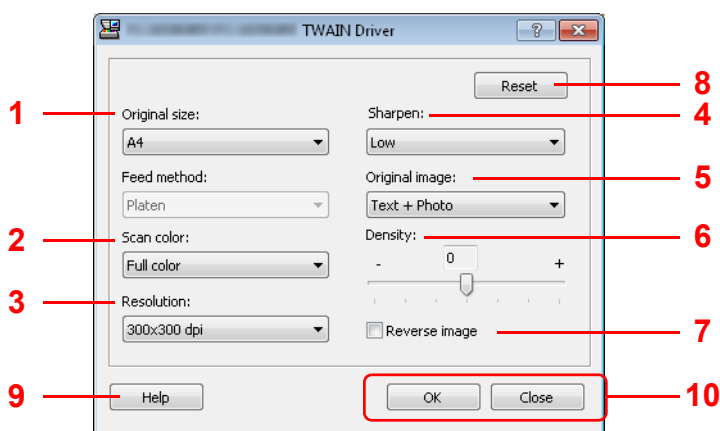

No.	Item	Description
1	Original size	Specify the size of originals being scanned. Value: Letter, Statement, Executive, A4, A5, A6, B5 (JIS), B5 (ISO), 16K, Custom Note Refer to <i>Configuration</i> on page 2-36 for selecting Custom .
2	Scan color	Select the color mode setting. Value: Monochrome, Grayscale, Full color
3	Resolution	Select fineness of scanning resolution. Value: 200 × 200 dpi, 300 × 300 dpi, 400 × 400 dpi, 600 × 600 dpi
4	Sharpen	Adjust the sharpness of the image. Value: None, Low, Medium, High, Descreen (Blurs the outlines and reduces the sharpness.)

No.	Item	Description
5	Original image	Select original image type for best results. Value: Text, Photo, Text+Photo
6	Destiny	Select the density. Value: -3 (Lighter) to 3 (Darker)
7	Reverse image	When this is selected, the image color reverses.
8	Reset	Reset the settings to the previous settings.
9	Help	Displays the Help screen.
10	OK/Close	Clicking OK exits the TWAIN Settings after applying the modified scan settings. Clicking Close exits the TWAIN Settings without applying the modified scan settings.

Quick Scan Settings

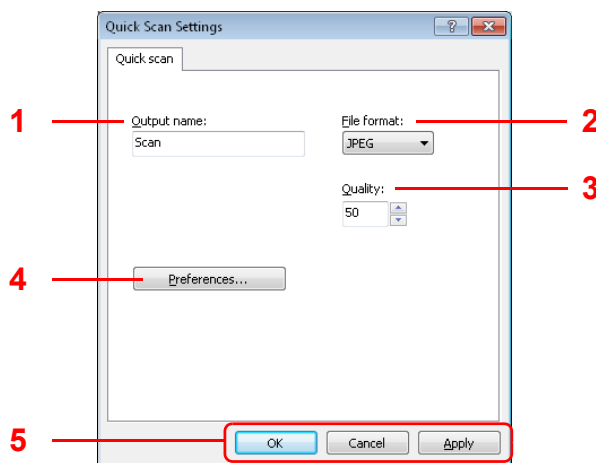

No.	Item	Description
1	Output name	Assign a document name to scanned images. When multiple images are saved in the same folder, a three-digit incrementing number such as Scan_001, Scan_002... is appended to the end of the file name. Up to 16 characters can be entered.
2	File format	Specify the image file format. Value: BMP, JPEG, PNG, TIFF, PDF Note In Scan to PDF, all images are saved in PDF format.
3	Quality	Set the image quality if File format is JPEG . The higher quality becomes the lower compression. This is disabled for non-JPEG format. Value: 1 to 100 Note Non-numeric characters cannot be entered. If entered number is beyond range, the max/min value will be restored.
4	Preferences	Displays the TWAIN settings screen. For detail, refer to <i>TWAIN Settings</i> on page 2-34.
5	OK/Cancel/Apply	Clicking OK exits the Quick Scan Settings after applying the modified scan settings. Clicking Cancel exits the Quick Scan Settings without applying the modified scan settings. Clicking Apply applies the modified scan settings without exiting the Quick Scan Settings.

Configuration

The Configuration is a function of KYOCERA Client Tool. The default settings of the machine can be changed and the messages that appear in the Status Monitor can be set.



Note For the detailed functions of the Configuration, refer to *KYOCERA Client Tool User Guide*.

Accessing the Configuration

Follow these steps to display the Configuration on the desktop.

- 1 Start KYOCERA Client Tool as explained in *Accessing KYOCERA Client Tool* on page 2-22.
- 2 Click **Configuration** on the **Device** tab. The Configuration opens.



Configuration Screen

General

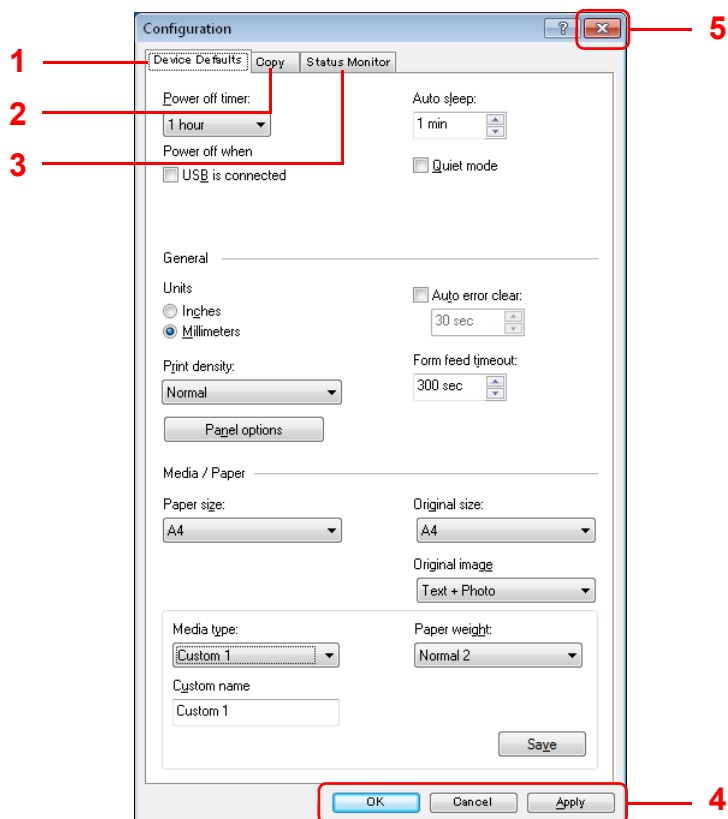

No.	Item	Description	Reference Page
1	Device Defaults	Configure overall machine operation.	2-38
2	Copy	Configure settings for copying functions.	2-40
3	Status Monitor	Configure settings for the Status Monitor.	2-41
4	OK/Cancel/Apply	Clicking OK exits the Configuration after applying the modified machine settings. Clicking Cancel exits the Configuration without applying the modified machine settings. Clicking Apply applies the modified machine settings without exiting the Configuration.	—
5	—	Close the Configuration.	—

Device Defaults Tab

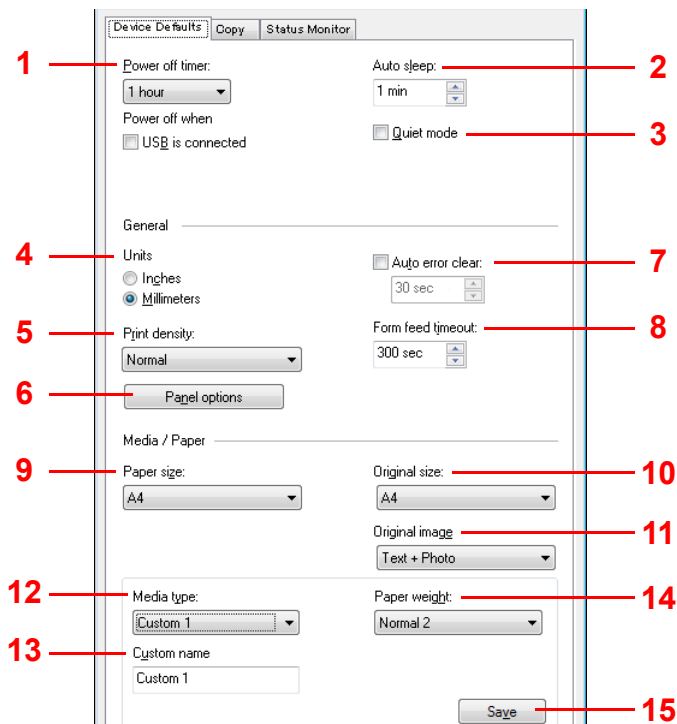

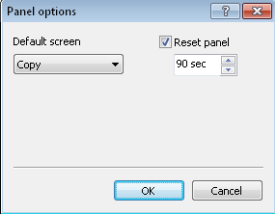
No.	Item	Description
1	Power off timer	Select the length of time before the machine shuts off automatically when not in use. The default preset time is 1 hour . Value: 1 to 6 hours, 9 hours, 12 hours, 1 day to 1 week Also, selects whether or not to turn the power off automatically when a USB is connected. Note Power off when does not appear on the FS-1020MFP for Europe, Russia, Africa and Middle East, and FS-1220MFP for Europe.
2	Auto sleep	Set the sleep timer for the machine to go into sleep mode when not in use. The default preset time is 1 minute. Value: 1 to 240 minutes (1 minute increments)
3	Quiet mode	Turn on Quiet Mode. Refer to <i>Quiet Mode</i> on page 1-4.
4	Units	Select Inches or Millimeters for the unit for paper dimensions.
5	Print density	Adjust density using 5 levels. Value: Light, Medium light, Normal, Medium dark, Dark
6	Panel options	Opens Panel options screen.  <ul style="list-style-type: none"> Default screen: Select the screen appearing right after start-up (default screen). Note To enable the change immediately, turn the machine OFF and then ON. Otherwise wait until the machine once enters the sleep and then resumes. Reset panel: If no jobs are run for a certain period of time, automatically reset settings and return to the default setting. If you select On for Reset panel, set the amount of time to wait before Reset panel.

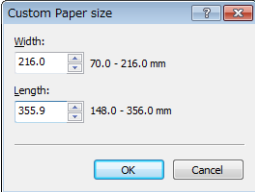
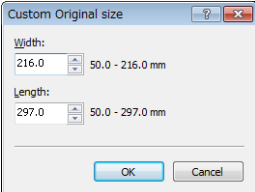
No.	Item	Description
7	Auto error clear	<p>Enable auto error clear. If an error occurs during processing, processing stops to wait for the next step to be taken by the user. In the auto error clear mode, automatically clear the error after a set amount of time elapses.</p> <p>If you select On for auto error clear, set the amount of time to wait before automatically clearing errors.</p> <p>Value: 5 to 495 seconds (every five seconds)</p>
8	Form feed timeout	<p>When receiving print data from the computer, the machine may sometimes wait if there is no information signaling that the last page does not have any more data to be printed. When the preset timeout passes, the machine automatically prints the documents. The options are between 5 and 495 seconds.</p> <p>Value: 5 to 495 seconds (every five seconds)</p>
9	Paper size	<p>Set the default paper size to load in the cassette.</p> <p>Value: Letter, Legal, Statement, Executive, A4, A5, A6, Folio, B5 (JIS), B5 (ISO), Oficio II, 216 × 340 mm, 16K, Custom size</p> <p>When a Custom size is selected, the Custom Paper size screen appears.</p>  <p>Type or select values for Width and Length. If the Width or Length value exceeds the allowable limit, it automatically adjusts to the limit after OK is clicked.</p>
10	Original size	<p>Set the default original size to be scanned.</p> <p>Value: Letter, Statement, Executive, A4, A5, A6, B5 (JIS), B5 (ISO), 16K, Custom size</p> <p>When a Custom size is selected, the Custom Original size screen appears.</p>  <p>Type or select values for Width and Length. If the Width or Length value exceeds the allowable limit, it automatically adjusts to the limit after OK is clicked.</p>
11	Original image	<p>Set the default image quality.</p> <p>Value: Text + Photo, Photo, Text, Text + High resolution photo</p>
12	Media type	<p>Set the default media type to load in cassette.</p> <p>Value: Plain, Preprinted, Labels, Bond, Recycled, Vellum (60 to 64 g/m²), Rough, Letterhead, Color, Prepunched, Envelope, Cardstock, Thick (90 to 220 g/m²), High quality, Custom 1-8</p> <p>When Custom 1-8 is selected, the Custom name appears.</p>
13	Custom name	<p>Change names for Custom 1-8. Selecting media type, the name after change will be displayed.</p>
14	Paper weight	<p>Select weight for each media type. For details, refer to <i>Paper Type</i> on page 2-11.</p> <p>Value: Light, Normal 1, Normal 2, Normal 3, Heavy 1, Heavy 2, Heavy 3</p>
15	Save	<p>Save the Paper weight and Custom name settings that are set for Custom 1-8.</p>

Copy Tab

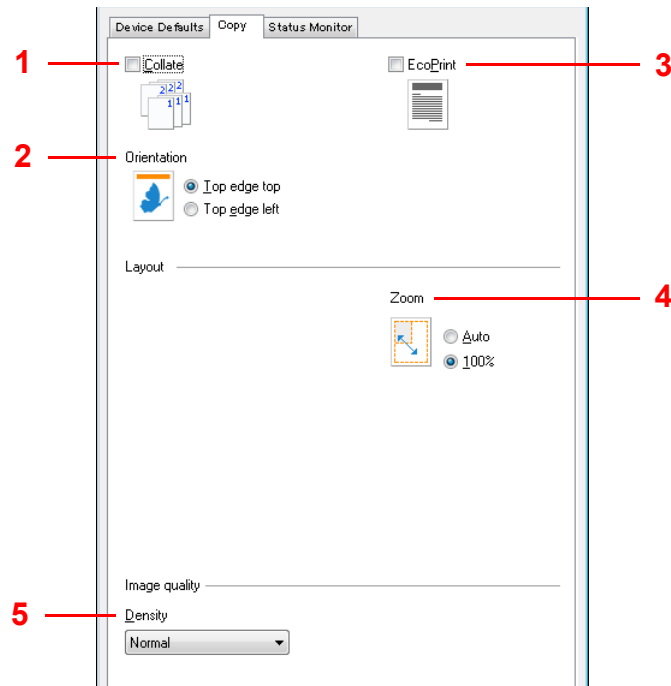

No.	Item	Description
1	Collate	Select the defaults for Collate.
2	Orientation	Set the original orientation defaults. Value: Top edge top, Top edge left
3	EcoPrint	Select the EcoPrint default.
4	Zoom	Select the default zoom setting. Value: Auto, 100%
5	Density	Set the default value for the copy density. Value: Lighter (-3), Lighter (-2), Lighter (-1), Normal, Darker (+1), Darker (+2), Darker (+3)

Status Monitor Tab

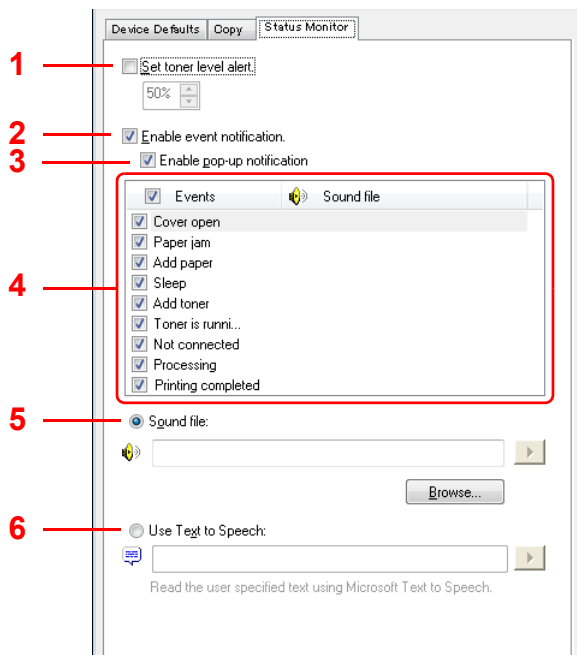

No.	Item	Description
1	Set toner level alert	Select to create an alert when the toner starts running low, and then select a percentage between 0 and 100. If the toner level goes below this percentage, an alert icon is displayed on the Supplies tab at the bottom of KYOCERA Client Tool screen.
2	Enable event notification	Select to activate the notification feature for selected machine events. When selected, notification options are available.
3	Enable pop-up notification	When selected, a pop-up message appears in the lower right corner of the screen for each selected event as it occurs.
4	Events list	Select one or more events for the notification. To select all events, select Events .
5	Sound file	With one or more events selected, select to enable sound notification. Type the location of a sound file (.WAV), or click Browse to find a sound file located on your computer. You can press the arrow button to hear the selected sound.
6	Use Text to Speech	With one or more events selected, select and type your preferred text. The Microsoft Text to Speech utility reads the text and plays it in a spoken voice. You can press the arrow button to hear the selected text.

Printing the Status Page

You can print the Status Page to check the current settings.

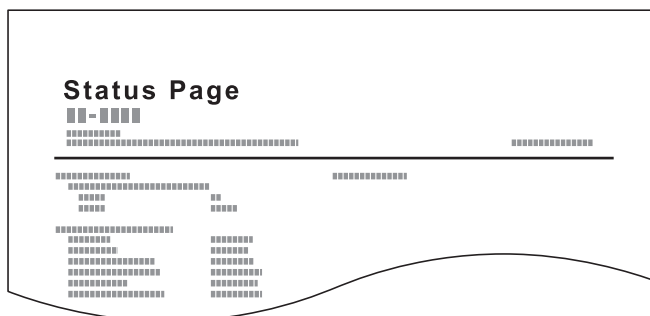

To print the status page, hold down the Mode Select key for 5 seconds.

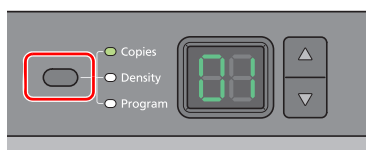

3 Copying

This chapter explains the following topics:

Basic Operation	3-2
Manual Duplex	3-3
Using Programs	3-5
Copying Functions	3-5
ID Card Copy	3-6

Basic Operation

Follow the steps as below for basic copying.

- 1 Configure necessary settings in KYOCERA Client Tool in advance. Refer to *Machine Settings* on page 2-22.

- 2 Press **[Copy]**.

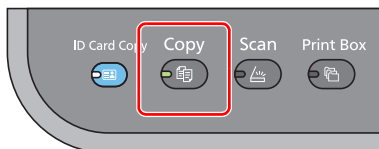

- 3 Place the originals. For details, refer to *Loading Originals* on page 2-16.

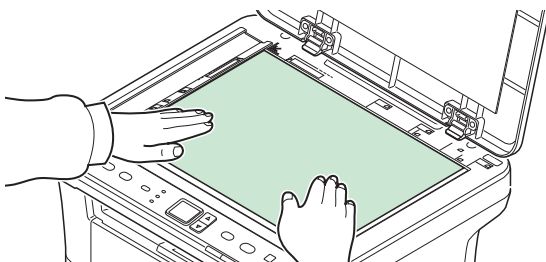

- 4 To use a program, select the program number (P0 to P3).



Press the Mode Select key to select **Program**, and press **[▲]** or **[▼]** to select the program number.

 **Note** For details on functions that are registered in programs, refer to *Using Programs* on page 3-5.

P0 is the status with no program set.

- 5 Enter the number of copies.



Press the Mode Select key to select **Copies**, and press **[▲]** or **[▼]** to enter the number of copies.

- 6 Adjust density using 7 levels (-3 (Lighter) to 3 (Darker)).



Press the Mode Select key to select **Density**, and press **[▲]** or **[▼]** to select your desired density.

- 7 Press **[Start]** to start copying.

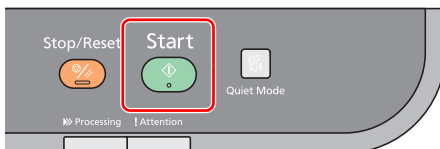

Manual Duplex

To copy on both sides of the paper, use Manual Duplex.

- 1 Select copy functions and place the front-side original (or odd numbered page) as explained in *Basic Operation* on page 3-2.

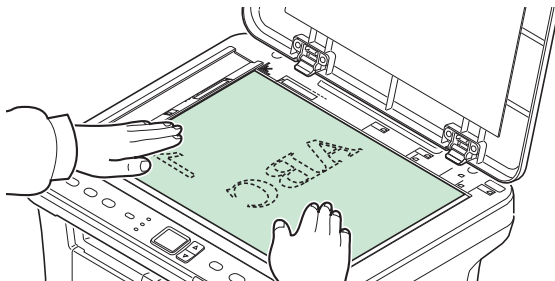

- 2 Press **[Start]** to start copying. The front side is copied.

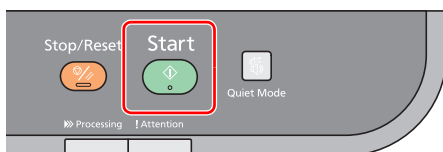

- 3 Retrieve the paper from the inner tray. If copying on multiple sheets, fan through the sheets to separate them prior to loading.

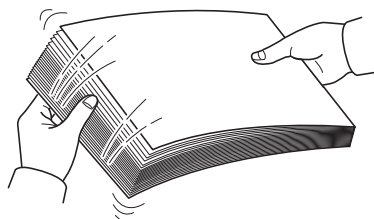

If the paper is curled at an edge, straighten it prior to reloading.

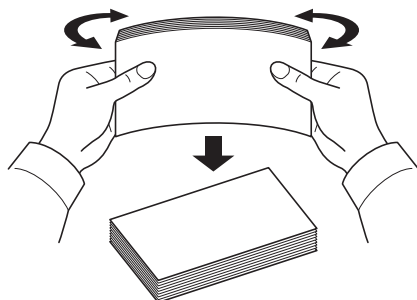

- 4 Copy the back side (or even numbered page). Load the paper as shown.

Long Edge Binding



Short Edge Binding

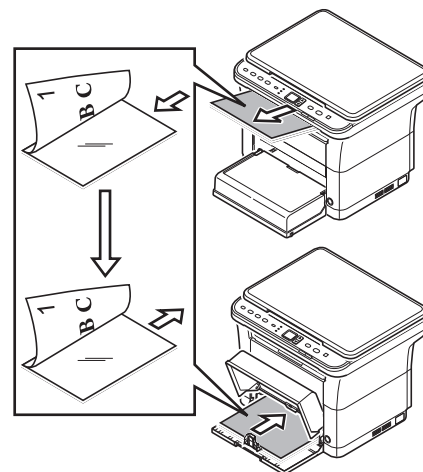
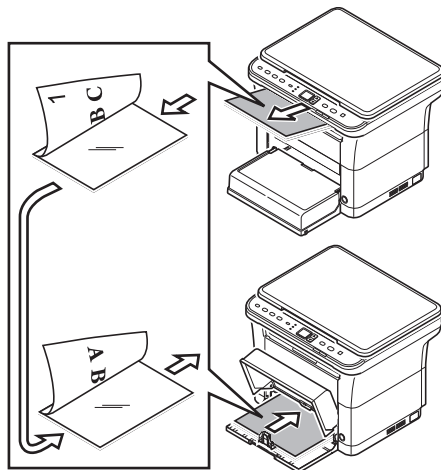
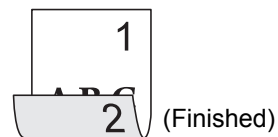

- 5 Place the back-side original (or even numbered page). For details, refer to *Loading Originals* on page 2-16.

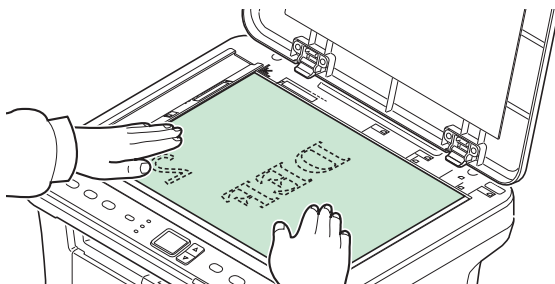

- 6 Press **[Start]**. The back side is copied, and duplex copying is completed.

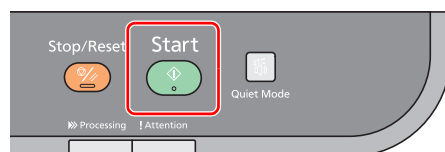

Using Programs

If there are settings that you frequently change from the default state, register the settings in a program. You can simply select the program number as needed to recall those functions.

Copy functions can be registered in three programs.

The programs below have been preregistered. The registered contents can be re-registered for easier use in your environment.

Item	Program1	Program2	Program3
Original size	A4 (Letter)	A4 (Letter)	A4 (Letter)
Original image	Text	Text+Photo (300 dpi)	Photo
Copies	1	1	1
Collate	On	On	On
Original orientation	Top Edge Top	Top Edge Top	Top Edge Top
Zoom	Auto	Auto	Auto
Density	Darker (+3)	Lighter (-2)	Normal (0)
EcoPrint	Off	On	Off
Combine	Off	2in1 (Left to right)	Off



Note For details on program registration and the various functions, refer to *Program Settings* on page 2-28. Refer to *Basic Operation* on page 3-2 for recalling programs.

Copying Functions

Copying functions are as follows. These functions are all configured from KYOCERA Client Tool.

Item	Description
Original size	Specify the size of originals being scanned. Value: Executive, Letter, A4, A5, A6, B5 (JIS), B5 (ISO), Custom, 16K, Statement
Original image	Select image quality suited to the type of original. Value: Text + Photo (300 dpi or 600 dpi), Photo, Text
Collate*	Scan multiple originals and deliver complete sets of copies as required according to page number. Value: Off, On
Zoom	Adjust the magnification to reduce or enlarge the original image. Value: 100%, Auto, Fixed, Custom
Density	Adjust density using 7 levels. Value: Lighter (-3), Lighter (-2), Lighter (-1), Normal (0), Darker (+1), Darker (+2), Darker (+3)
EcoPrint	Use EcoPrint to save toner when printing. Use this function for test copies or any other occasion when high quality print is not required. Value: Off, On
Combine*	Combine 2 or 4 original sheets into 1 copied page. You can select the page layout. Value: Off, 2in1, 4in1

* When this function is selected, printing starts after all pages to be copied are scanned. Place one page at a time and press **[Start]**. When you have finished scanning all pages, press **[▲]** or **[▼]** to select – and press **[Start]** again to start printing.



Note To set a function from KYOCERA Client Tool, refer to *Default and Program Settings* on page 2-28.

ID Card Copy

Use to copy the front and back sides of a license or other ID card on one sheet of paper.

- 1 Press **[ID Card Copy]**.

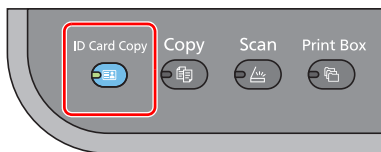

- 2 Place the original. Align with the **ID Card** marks on the Original Size Indicator Plates.

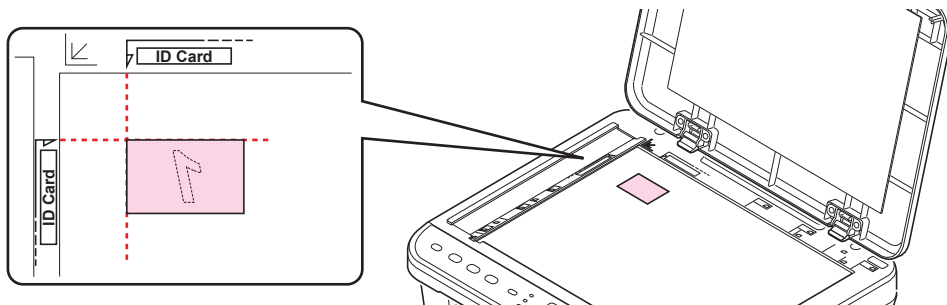

For details, refer to *Loading Originals* on page 2-16.

- 3 Enter the number of copies. (Refer to *Basic Operation* on page 3-2.)
- 4 Adjust density. (Refer to *Basic Operation* on page 3-2.)
- 5 Press **[Start]**. 1- appears in the display on the operation panel and the first side of the card is scanned.

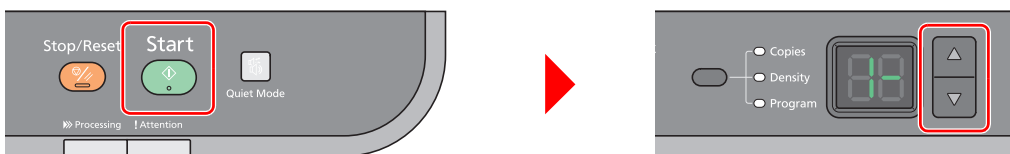

After the first side is scanned, 2- appears in the display.

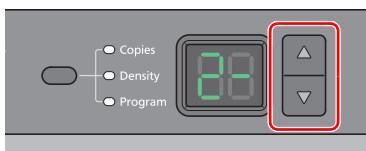

- 6 Turn the original over. Align with the **ID Card** marks on the Original Size Indicator Plates.

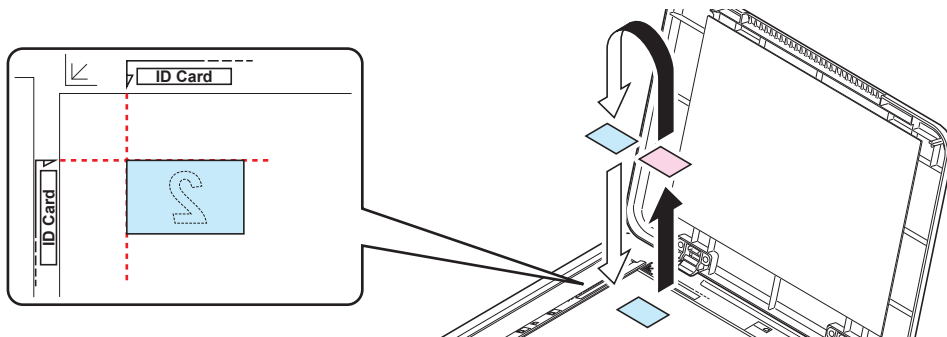

- 7 Press **[Start]**. The front and back sides of the card are copied on one sheet of paper.

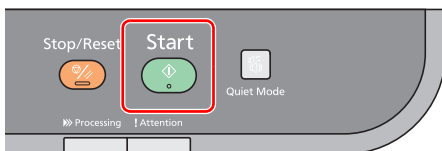

4 Printing

This chapter explains the following topics:

Printing from Application Software	4-2
About GX Driver	4-2
Manual Duplex	4-3
Print Box	4-5
Changing the Default Printer Driver Settings (Windows 7 for example)	4-6

Printing from Application Software

The steps required to print a document created with an application are explained below. You can select the printing paper size.

 **Note** You can also select the various settings by clicking **Properties** to open the **Properties** screen. Refer to *About GX Driver*.

- 1** Load the paper required into the cassette.
- 2** From the application **File** menu, select **Print**. The **Print** screen appears.
- 3** Click the drop-down list of printer names. All the installed printers are listed. Click the name of the printer.
- 4** Use **Number of copies** to enter the number of copies required. Up to 999 copies can be printed. For Microsoft Word, we recommend that you click **Options and specify Use printer settings** for the Default tray.
- 5** To start printing, click **OK**.

About GX Driver

GX Driver consists of the following tabs.

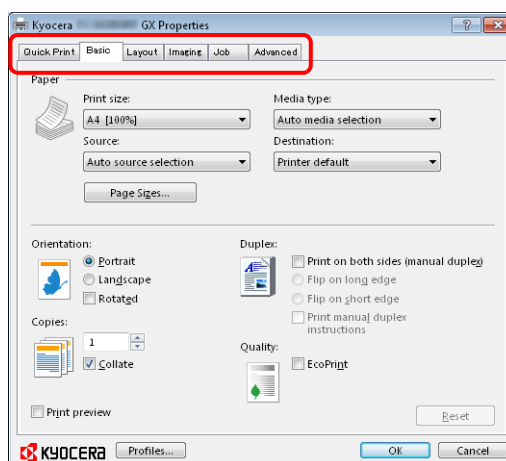

Tabs	Description
Quick Print	Use this tab to define basic print options into group profiles that can be accessed quickly and easily.
Basic	Use this tab to select the page size and orientation. The paper source is also selected.
Layout	Use to create multiple pages on a single sheet of paper. Also contains the scaling option.
Imaging	Select this tab to change the print quality and graphic settings.
Job	Use to save a print job in a Print Box. Refer to <i>Print Box</i> on page 4-5.
Advanced	Use to set up and add watermarks to your output.

Manual Duplex

To print on both sides of the paper, use *Manual Duplex*. The even pages are printed first and then reloaded to print the odd pages. An instruction sheet is available to assist with loading the sheets in the correct orientation and order.

 **Note** Ensure **Print manual duplex instructions** is selected to receive the instruction sheet. Continue to use the sheet until you are familiar with this feature.

1 Select **Print on both sides (manual duplex)**.

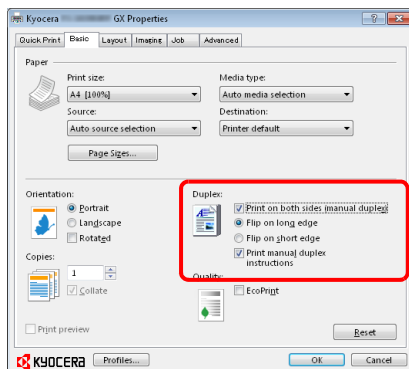

Select **Flip on long edge** if the binding will be on the long edge or **Flip on short edge** if the binding will be on the short edge. Select **Print manual duplex instructions** to receive the instruction sheet.

2 Select **OK** to return to the **Print** screen and select **OK** to start printing. A **Manual Duplex Instruction** message box displays. The even pages are printed including the instruction sheet.

 **Note** Instructions for manual duplex will be printed on the instruction sheet.

3 Remove all the even pages (including the instruction sheet) from the inner tray, fan through the sheets to separate them prior to loading.

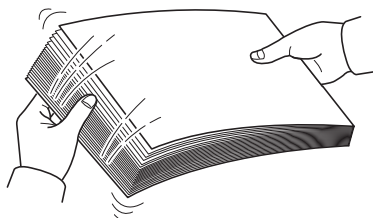

If the paper is curled at an edge, straighten it prior to reloading.

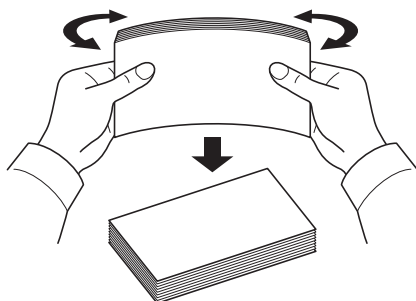



- 4 Load the even pages printed into the cassette with the instruction sheet facing down and the arrows pointing toward the machine.

Long Edge Binding

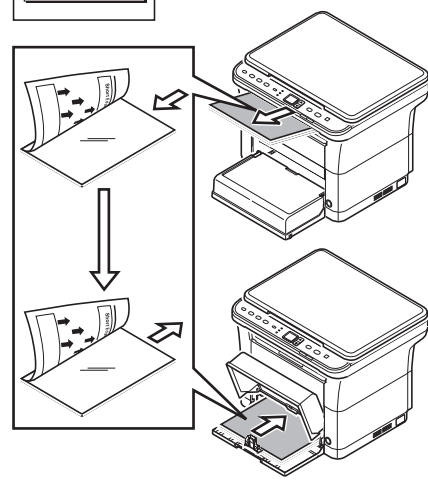
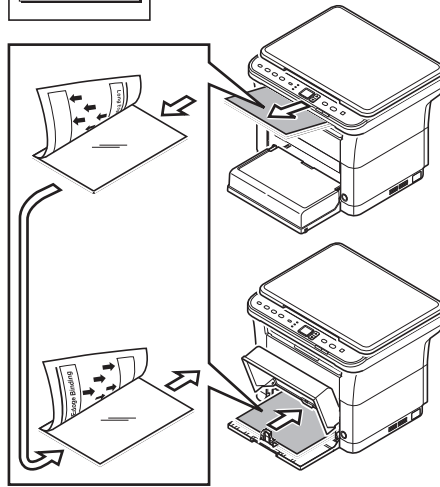
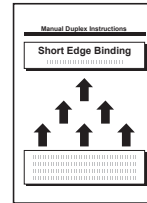
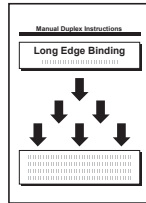
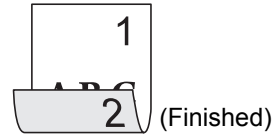

Short Edge Binding



 **Note** If the paper is considerably curled in one direction, roll the paper in the opposite direction to counteract the curl. If this will not cancel the curl satisfactorily, try to reduce the number of sheets loaded in the cassette to the maximum of 100.

- 5 Select **OK** in the **Manual Duplex Instruction** message box of the printer driver screen. All the odd pages will be printed.

Print Box

A print job can be saved in Print Box in the computer and printed from the machine when needed. Use the machine's operation panel to print the print job stored in a Print Box.

The four possible selections for the Print Box are the Default box and Boxes 1 - 3.

 **Note** The folder to be used for Boxes 1 - 3 can be set in the Preset Tool. Refer to *Program Settings* on page 2-28.

Saving to a Print Box

Save a print job to a Print Box.

- 1 From the application **File** menu, select **Print**. The **Print** screen appears.
- 2 Click **Properties**. The **Properties** screen appears.
- 3 Select **Job** tab.
- 4 Select **Job storage** then select the Print Box where the print job should be stored from the **Default, Box 1, Box 2 or Box 3**.

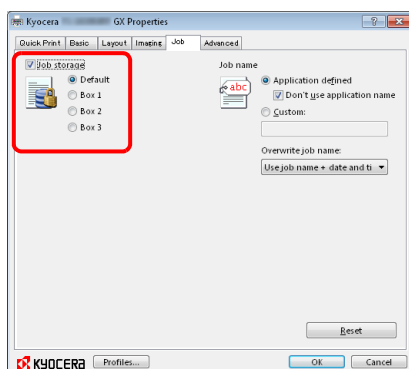

- 5 Set the job name for the print job.

Settings	Filename
Application define and Don't use application name	<Document name> <month><day><year> <hour><minutes><seconds>.prn Example: PrintBox.docx Filename: PrintBox 040112 030201.prn
Application define	<Application name> <month><day><year> <hour><minutes><seconds>.prn Example: PrintBox.docx Filename: Microsoft Word 040112 030201.prn
Custom and Use job name + date and time	<Custom name> <month><day><year> <hour><minutes><seconds>.prn Example: Custom name is Print_A. Filename: Print_A 040112 030201.prn
Custom and Replace existing file	<Custom name>.prn Example: Custom name is Print_A. Filename: Print_A.prn Note Any stored job with the same name will be overwritten.

- 6 Select **OK** to return to the **Print** screen and click **OK** to start storing.

Printing from Print Box

Print a print job saved in a Print Box.



Note All print jobs saved in the selected Print Box are printed.

KYOCERA Client Tool must be running on the computer from which printing from Print Box is executed. Refer to *Machine Settings* on page 2-22.

After being printed, the print jobs in the Print Box are deleted.

- 1 Press **[Print Box]**. P0 appears in the operation panel display.

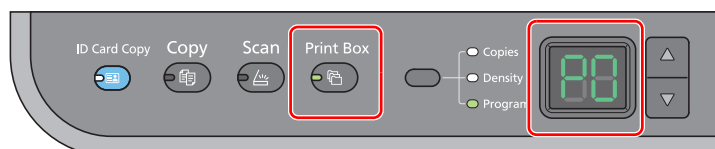

- 2 Press **[▲]** or **[▼]** to select the Print Box number (P0 to P3).

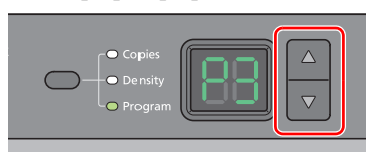

When P0 is selected, jobs saved in Default box are printed.

The following boxes are pre-registered in the Print Box Program.

P1: Box 1

P2: Box 2

P3: Box 3



Note The folders for Boxes 1 - 3 can be changed with the Preset Tool. Refer to *Program Settings* on page 2-28 for registering programs.

- 3 Press **[Start]** to start printing.

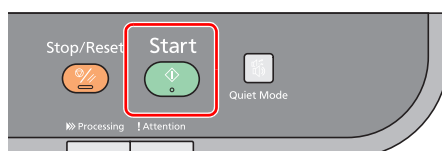

Changing the Default Printer Driver Settings (Windows 7 for example)

The default printer driver settings can be changed. By selecting frequently used settings, you can omit steps when printing.

The procedure is as follows.

- 1 Click the **start** button, and then click **Devices and Printers**.
- 2 Right-click the printer driver icon of the machine, and click the **Printer properties** menu of the printer driver.
- 3 Click the **Printing Preferences** button on the **General** tab.
- 4 Select the default settings and click the **OK** button.

For the settings, refer to *Printer Driver User Guide*.

5 Scanning

This chapter explains the following topics:

Push Scan	5-2
Using Programs	5-3
Quick Scan (Scan to PDF/Scan to Email/Scan to Folder)	5-4
Scanning using TWAIN/WIA	5-5

Push Scan

It is easy to scan from the operation panel on the machine. Push Scan performs scanning with the following settings. P0 is the status of scanning without using the preset program.

Item	Value
Original size	If unit setting is inch : Letter If unit setting is mm : A4 For details on unit setting, refer to <i>Configuration</i> on page 2-36.
Resolution	300 × 300 dpi
Reverse image	Unchecked
Sharpen	None
Original quality	Text + Photo
Scan color	Full color
Density	Normal (0)
Output name	Scan
File format	PDF
Destination folder	For Windows Vista/Windows 7: C:\Users\ <user >\my="" documents<br=""></user> For Windows XP: C:\Documents and Settings\ <user>\my documents<="" td=""> </user>\my>



Note The Program is used to change the settings. Refer to *Using Programs* on page 5-3.

When using Push Scan, KYOCERA Client Tool must be running on the computer. Refer to *Accessing KYOCERA Client Tool* on page 2-22.

- 1 Press **[Scan]**. P0 appears in the display on the operation panel.

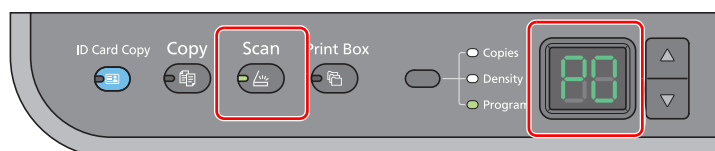

- 2 Place the originals. For details, refer to *Loading Originals* on page 2-16.

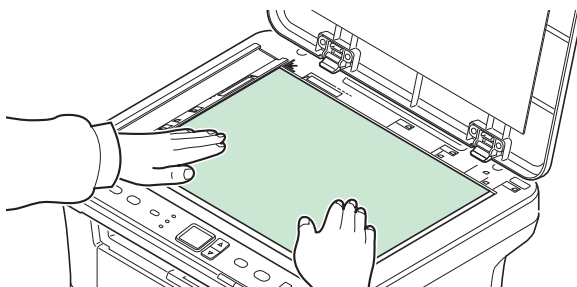

- 3 To use a program, select the program number (P0 to P3).

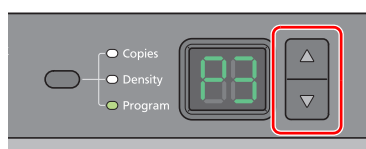

Press **[▲]** or **[▼]** to select the program number.



Note For details on functions that are registered in programs, refer to *Using Programs* on page 5-3.

- 4 Press **[Start]** to start scanning.

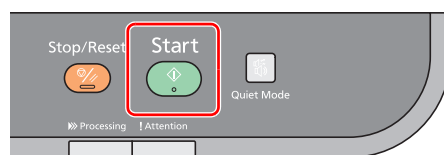

Using Programs

If there are settings that you frequently change from the default state, register the settings in a program. You can simply select the program number as needed to recall those functions.

Scan functions can be registered in three programs.

The programs below have been preregistered. The registered contents can be re-registered for easier use in your environment.

Item	Program1	Program2	Program3
Name	Folder 1	Folder 2	Folder 3
Original size	A4 (Letter)	A4 (Letter)	A4 (Letter)
Original image	Text	Text + Photo	Photo
Reverse image	Off	Off	Off
Sharpen	Low	Low	Low
Scan color	Full color	Full color	Full color
Density	Normal (0)	Normal (0)	Normal (0)
Resolution	300 × 300 dpi	300 × 300 dpi	300 × 300 dpi
Output name	Scan	Scan	Scan
File format	PDF	PDF	PDF
Quality	—	—	—
Destination folder	C:\User\ <user>\My Documents (Windows Vista/Windows 7) C:\Document and Settings\<user>\My Documents (Windows XP)</user></user>		



Note For details on program registration and the various functions, refer to *Program Settings* on page 2-28.

Refer to *Push Scan* on page 5-2 for recalling programs.

Quick Scan (Scan to PDF/Scan to Email/Scan to Folder)

Execute scanning from KYOCERA Client Tool. With Quick Scan, the following 3 types of scan are possible.

Scan to PDF: Saves the scanned image in PDF format. The folder is specified after scanning.

Scan to Email: Attaches the scanned image to a new E-mail message.

Scan to Folder: Saves the scanned image to a specified folder.



Note The folder in which the scanned image is saved and the file format can be set in advance in KYOCERA Client Tool. Refer to *Quick Scan/TWAIN Settings* on page 2-34.

- 1 Place the originals. For details, refer to *Loading Originals* on page 2-16.

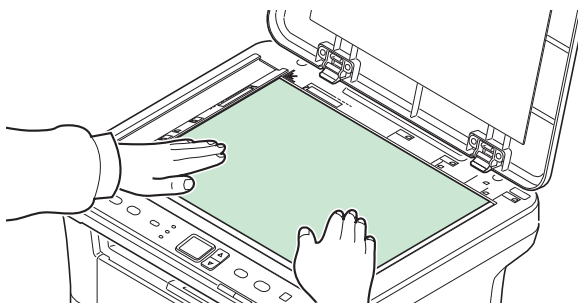

- 2 Start KYOCERA Client Tool as explained in *Accessing KYOCERA Client Tool* on page 2-22.
- 3 Click **Scan to PDF**, **Scan to Email** or **Scan to Folder** icon on the **Scan** tab.

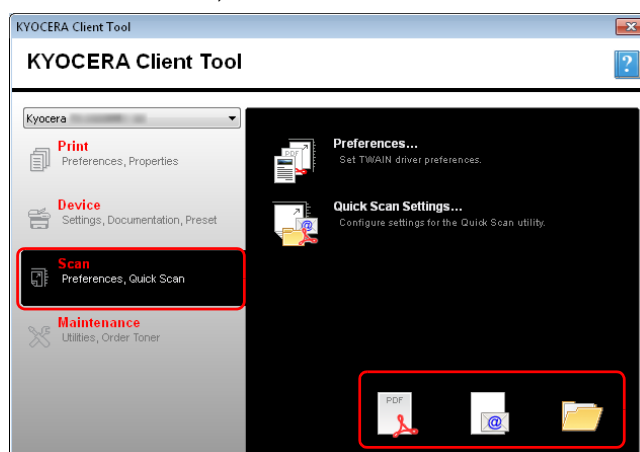

- 4 **Scan to PDF**

Scanning begins. When scanning finishes, the **Save PDF File As** dialog appears. Specify the PDF file name and the folder in which the image will be saved.

Scan to Email

Scanning begins. When scanning finishes, the mailer starts and the scanned image is attached. Enter the address, subject and message, and then send.

Scan to Folder

The **Browse for Folder** dialog appears. Specify the folder in which the image will be saved, and click **[OK]**. Scanning begins.

Scanning using TWAIN/WIA

This section explains how to scan an original using TWAIN/WIA.

The procedure for scanning using the TWAIN driver is explained as an example. The WIA driver is used in the same way.

- 1 Place the originals. For details, refer to *Loading Originals* on page 2-16.

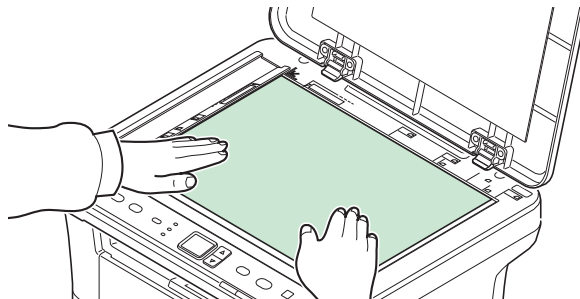

- 2 Activate the TWAIN compatible application.
- 3 Select the machine using the application and display the TWAIN screen.



Note For selecting the machine, see the Operation Guide or Help for each application software.

- 4 Select scanning settings in the TWAIN screen that opens.

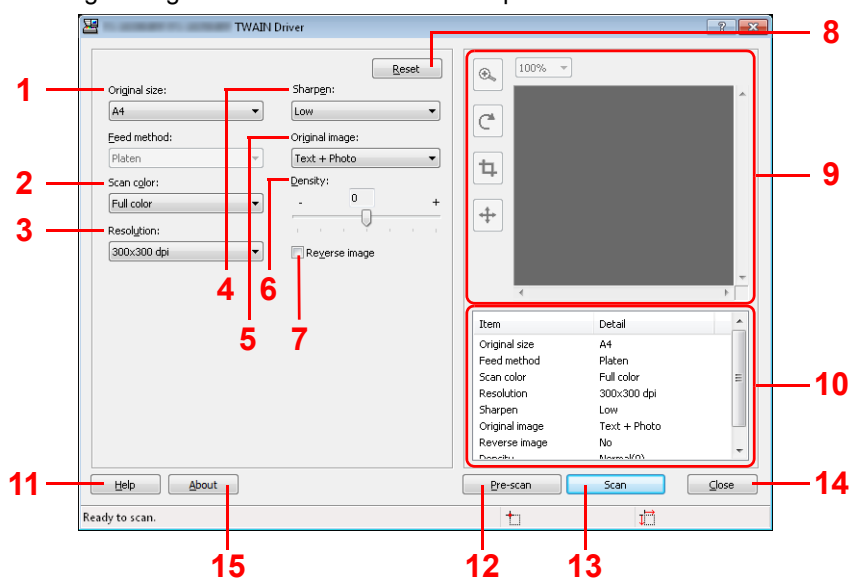

The settings that appear in the TWAIN screen are as follows.

No.	Item	Description
1	Original size	Specify the size of originals being scanned. Value: Letter, Statement, Executive, A4, A5, A6, B5 (JIS), B5 (ISO), 16K, Custom Note Refer to <i>Configuration</i> on page 2-36 for selecting Custom .
2	Scan color	Select the color mode setting. Value: Monochrome, Grayscale, Full color
3	Resolution	Select fineness of scanning resolution. Value: 200 × 200 dpi, 300 × 300 dpi, 400 × 400 dpi, 600 × 600 dpi

No.	Item	Description
4	Sharpen	Adjust the sharpness of the image. Value: None, Low, Medium, High, Descreen (Blurs the outlines and reduces the sharpness.)
5	Original image	Select original image type for best results. Value: Text, Photo, Text+Photo
6	Density	Select the density. Value: -3 (Lighter) to 3 (Darker)
7	Reverse image	When this is selected, the image color reverses.
8	Reset	Reset the settings to the default value.
9	Preview area	Displays a preview of the scanned image. The image can be enlarged, rotated, trimmed, or moved.
10	Details list	Displays a list of the settings.
11	Help	Displays the Help screen.
12	Pre-Scan	Acquires a preview image.
13	Scan	Performs the scan and returns the image to the application.
14	Close	Close the TWAIN screen.
15	About	Displays the driver version number.

6 Maintenance

This chapter explains the following topics:

General Information	6-2
Toner Container Replacement	6-2
Maintenance Kit Replacement	6-5
Cleaning the Machine	6-5
Maintenance Menu	6-7
Prolonged Non-Use and Moving of the Machine	6-8

General Information

This chapter describes basic maintenance tasks you can perform for the machine. You can replace the toner container according to the machine's status:

Also, the internal parts need periodic cleaning.



Note Information Collection on Memory Chips - The memory chip attached to the toner container is designed to improve convenience for the end user; to support the recycling operation of empty toner containers; and to gather information to support new product planning and development. The information gathered is anonymous - it cannot be associated to any specific individual and the data is intended to be used anonymously.

Toner Container Replacement

The **Attention** indicator identifies the toner status at two stages of toner usage.

- When the machine becomes low on toner, the **Attention** indicator flashes and a message appears in KYOCERA Client Tool. Note the replacement is not always necessary at this stage.
- If you ignore the above status and continue printing, E-0007 appears in the display on the operation panel, the **Attention** indicator will light up just before the toner is used up and the machine will stop. The toner container must then be replaced immediately.

In either case, replace the toner container.



Note If **Non-genuine toner is installed** appears in KYOCERA Client Tool after the toner container is replaced, the installed toner container is non-genuine.

The manufacturer assumes no responsibility for damage caused by a non-genuine toner.

We recommend that you only use genuine toner containers.

When you want to use the toner container currently installed, press the Mode Select key and [**Stop/Reset**] simultaneously for 3 seconds or more.

Frequency of toner container replacement

According to ISO 19752 and EcoPrint switched off the toner container can print as follows (A4/Letter paper is assumed): 2,500 pages (FS-1020MFP) or 1,600 pages (FS-1220MFP).

You can print a status page to check how much toner remains in the toner container. The Toner Gauge in the consumables status section on the status page shows a progress bar, which roughly represents how much toner is left in the toner container.

Starter Toner Container

The toner container packed with the new machine is a starter toner container. The starter toner container lasts an average of 700 pages.

Toner Kits

For best results, we recommend that you only use genuine Kyocera Parts and Supplies. Should any damage be caused by the application of a toner other than the original toner, then this damage is excluded from the guarantee.

A new toner kit contains the following items:

- Toner Container
- Plastic waste bag for old toner container
- Installation Guide



Note Do not remove the toner container from the carton until you are ready to install it in the machine.

Replacing the Toner Container

This section explains how to replace the toner container.



CAUTION Do not attempt to incinerate the Toner Container. Dangerous sparks may cause burns.

IMPORTANT During toner container replacement, temporarily move storage media and computer supplies (such as floppy disks) away from the toner container. This is to avoid damaging media by the magnetism of toner.

KYOCERA Document Solutions Inc. is not liable against any damages or problems arising from the use of toner containers other than those designated as original Kyocera toner containers. For optimum performance, it is also recommended to use only the Kyocera toner containers which are specifically intended for use in your country or region. If the toner container for another destinations is installed, the machine will stop printing.



Note You do not have to turn machine power off before starting the replacement. Any data that may be processing in the machine will be deleted if you turn the machine power off.

- 1 Open the front cover.

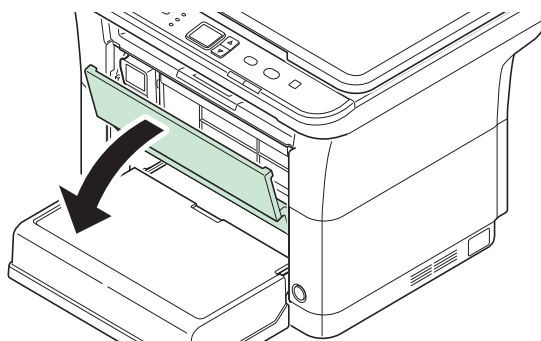

- 2 Pull out the toner container.

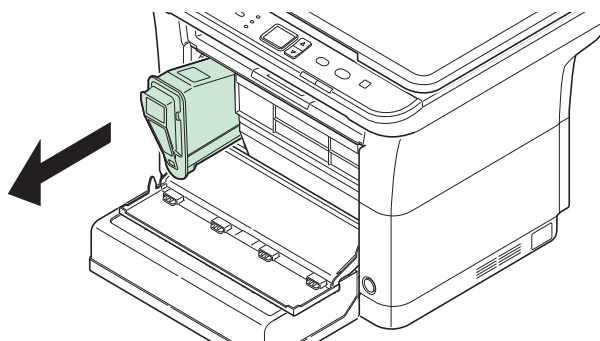

Note Put the old toner container in the plastic bag (supplied with the new toner kit) and discard it later according to the local code or regulations for waste disposal.

- 3 Take the new toner container out of the toner kit. Shake the new toner container at least 10 times as shown in the figure in order to distribute the toner evenly inside the container.

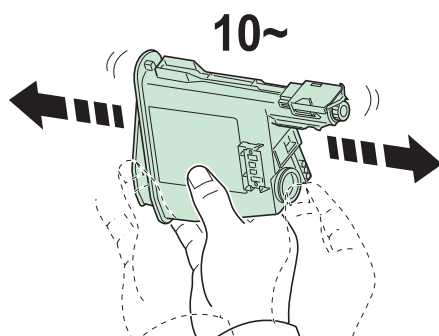

- 4 Install the new toner container in the machine. Push in firmly until you hear a "click" sound.

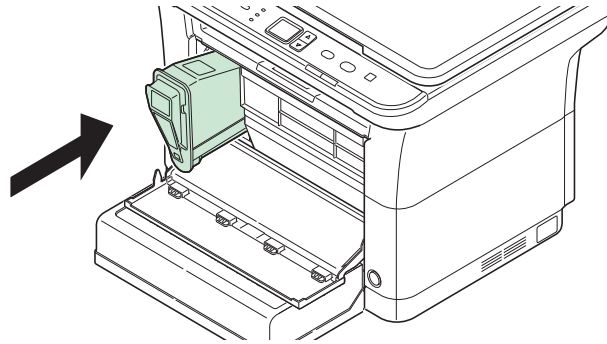

- 5 Close the front cover. Toner is replenished for about 4 seconds.

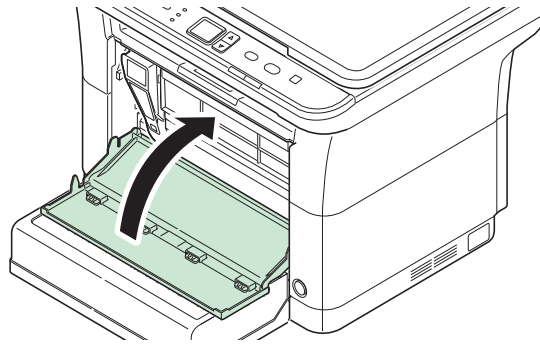

Note If the front cover does not close, check that the new toner container is installed correctly (in step 4).

After use, always dispose of the toner container in accordance with Federal, State and Local rules and regulations.

Maintenance Kit Replacement

When the machine prints 100,000 pages, a message is printed indicating that the maintenance kit should be replaced. The maintenance kit must then be replaced immediately.

To replace the maintenance kit, contact your service representative.

Contents:

- Drum unit
- Developer unit
- Waste toner box
- Feed roller
- Lower paper feed guide
- Transfer roller

Cleaning the Machine

Clean the machine regularly to ensure optimum output quality.

Original Cover/Platen

Wipe the backside of the original cover and the platen with a soft cloth dampened with alcohol or mild detergent.

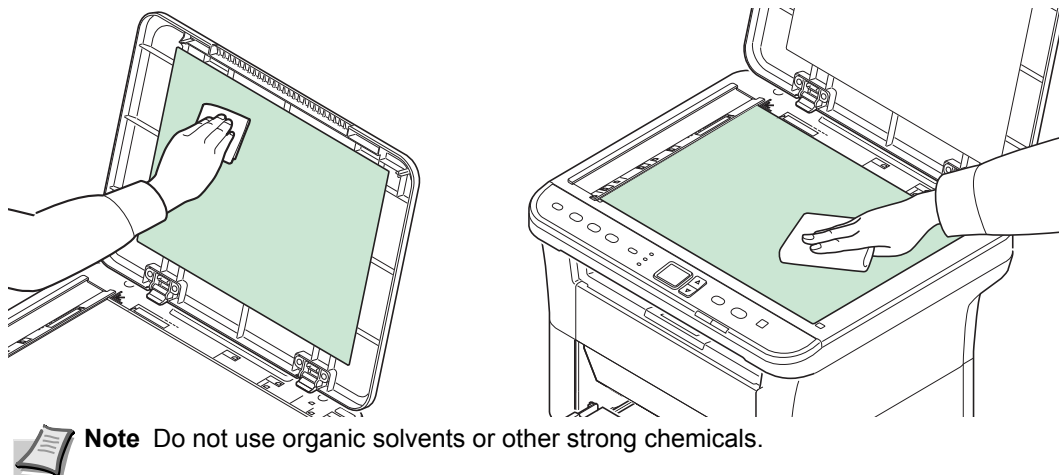

Interior of the Machine

To avoid print quality problems, the interior of the machine must be cleaned with every toner container replacement.

- 1 Open the rear cover.

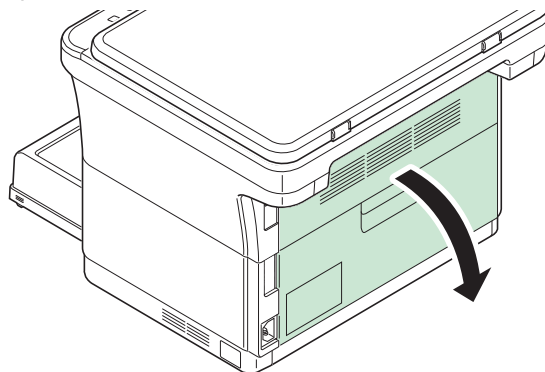

- 2 Use a clean, lint-free cloth to wipe dust and dirt off the metal and rubber rollers, conveying unit, and paper feed unit.

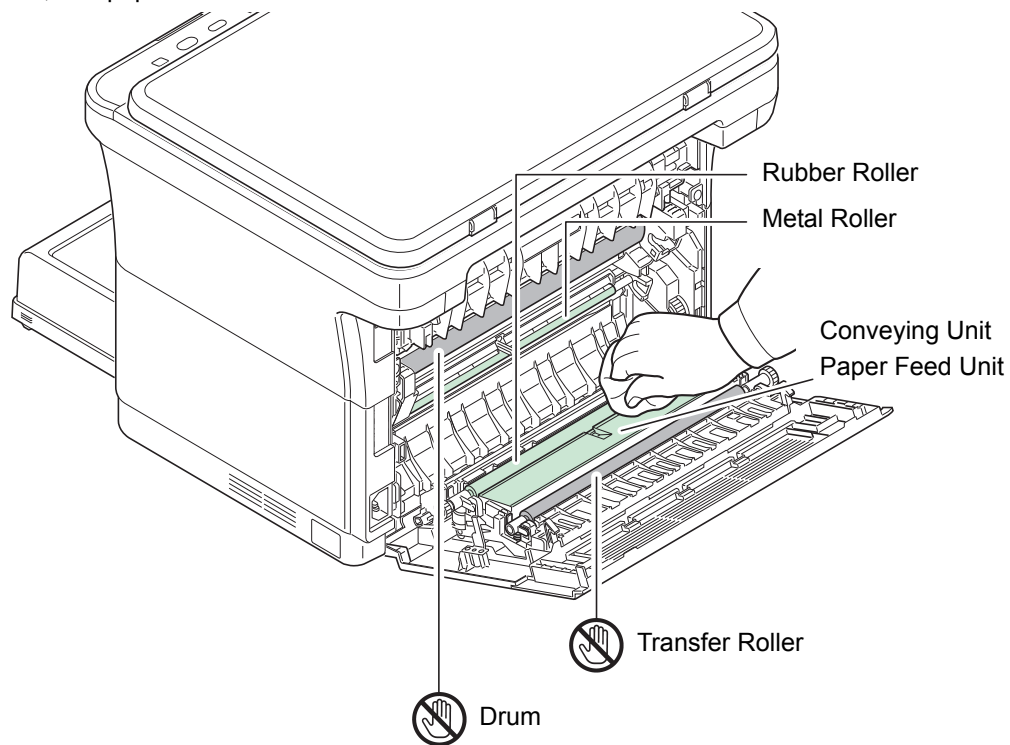



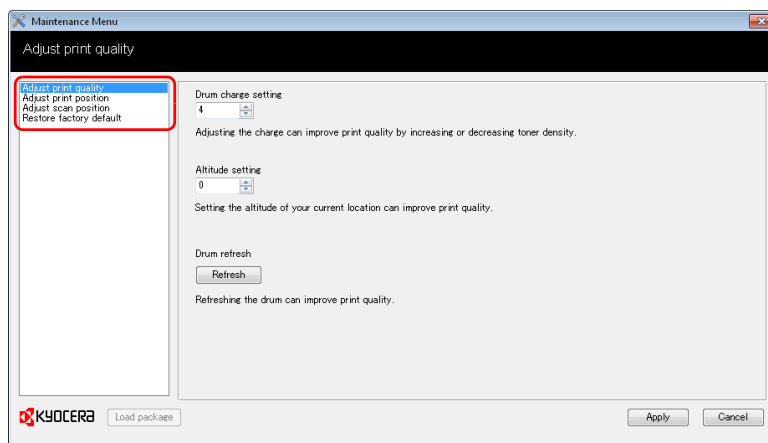

IMPORTANT Take care not to touch the drum and transfer roller (black) during cleaning.

Maintenance Menu

The Maintenance Menu that the user can adjust from KYOCERA Client Tool is described below. In addition, also refer to *KYOCERA Client Tool User Guide*.

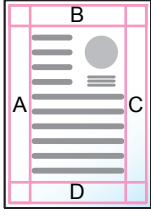

Maintenance Menu		Description
Adjust print quality	Drum charge setting	When print quality has deteriorated, the output of the main charger can be changed to restore print quality.
	Altitude setting	If you are using the machine at an altitude of 1500 m or higher and print quality has deteriorated, the Altitude setting can be used to restore print quality.
	Drum refresh	Perform Drum refresh when images show streaking with white lines.
Adjust print position	Printing start position	<p>Single-sided printing Adjust the position of the printed image.</p> <p>A: Left edge B: Top edge</p> <p>Top edge: +10</p>
	Print margins	<p>Adjust the width of the top edge, bottom edge, left edge and right edge margins.</p> <p>Note This setting is not effective for the printing from the machine.</p> <p>A: Left edge B: Top edge C: Right edge D: Bottom edge</p> <p>Top edge: +10</p>

Maintenance Menu		Description	
Adjust scan position	Scanning start position	Adjust the position of the scanned image.	  <p data-bbox="1310 517 1461 544">Platen: -10</p>
	Scan margins	Adjust the width of the top edge, bottom edge, left edge and right edge margins.	  <p data-bbox="1310 797 1461 824">Top edge: +10</p> <p data-bbox="1098 797 1249 913"> A: Left edge B: Top edge C: Right edge D: Bottom edge </p>
Restore factory default		Restore factory default settings.	

Prolonged Non-Use and Moving of the Machine

Prolonged Non-use

If you ever leave the machine unused for a long period of time, remove the power cord from the wall outlet.

We recommend you consult with your dealer about the additional actions you should take to avoid possible damage that may occur when the machine is used next time.

Moving the Machine

When you move the machine:

- Move it gently.
- Keep it as level as possible to avoid spilling toner inside the machine.
- Be sure to consult a service representative before attempting long distance transportation of the machine.
- Keep the machine horizontal.



WARNING If you are shipping the machine, remove and pack the developer unit and drum unit in a plastic bag and ship them separately from the machine.

7 Troubleshooting

This chapter explains the following topics:



Solving Malfunctions	7-2
Error Messages	7-7
Clearing Paper Jams	7-9





Solving Malfunctions

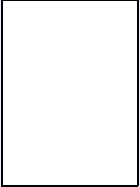

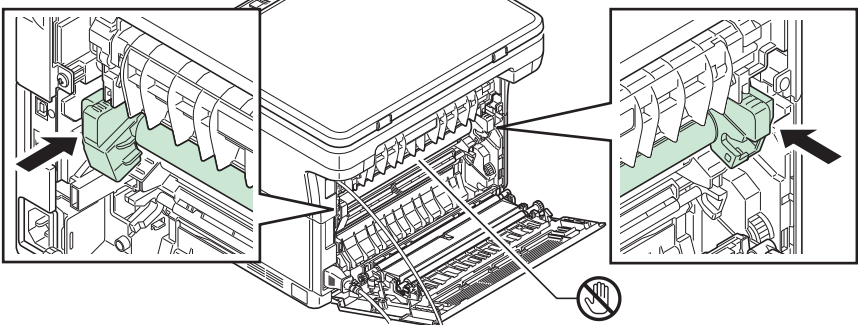
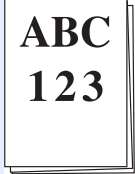

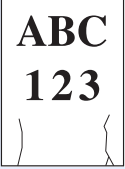
The table below provides general guidelines for problem solving.

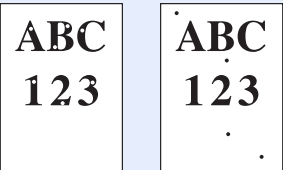

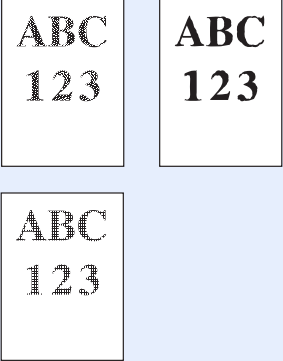
If a problem occurs with your machine, look into the checkpoints and perform procedures indicated on the following pages. If the problem persists, contact your service representative.

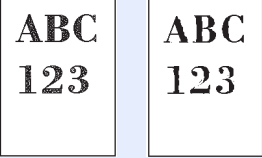
Symptom	Checkpoints	Corrective Actions	Reference Page
The screen does not respond when the power switch is turned on.	Check the power cord.	Connect both ends of the power cord securely.	2-2
Pressing [Start] does not produce copies.	Is there a message on the machine screen, KYOCERA Client Tool, or the Status Monitor?	Determine the appropriate response to the message and respond accordingly.	7-7
	Is the machine in Sleep mode?	Press any key on the operation panel to recover the machine from Sleep mode.	—
The indicators are off and the motor is not working.	Check the power cord.	Connect both ends of the power cord securely.	2-2
	—	Turn on the power.	—
The machine will not print from the computer.	Check the power cord.	Connect both ends of the power cord securely.	2-2
	Is the machine powered on?	Turn on the power.	—
	Are the interface cable connected?	Connect the correct interface cable securely.	2-2
	Was the machine powered on before the interface cable was connected?	Power on the machine after connecting the interface cable.	2-2
	Is the print job paused?	Resume printing.	—
	Is the Attention indicator lit or flashing? Does an error code appear in the display on the operation panel?	Using the information on page 7-7, check if an error has occurred and clear the error. If the indicators show a pattern not described on page 7-7, turn the power off and then on again. Print the job again.	7-7
	Check if a status page can be printed.	If the status page was printed successfully, there may be a problem with the connection to the computer. Check the connection. To print the status page, refer to <i>Printing the Status Page</i> on page 2-42.	2-2
The machine prints a status page but data from the computer is not being printed.	Check the interface cable.	Connect both ends of the interface cable securely. Try replacing the interface cable.	2-2
	Check program files and application software.	Try printing another file or using another print command. If the problem occurs with a specific file or application, check the printer settings for that application.	—

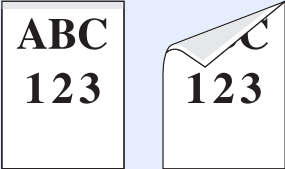
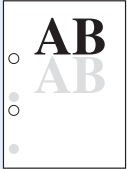
Symptom	Checkpoints	Corrective Actions	Reference Page
Vapor is emitted near the inner tray.	Check if the temperature is low near the location of the machine, or if the paper that is being used has been exposed to humidity.	Depending on the operating environment of the machine and the condition of the paper, heat generated during printing can evaporate water moisture in the printed paper, emitting vapor from the machine. In this case, printing can be continued without any problem. To correct this, increase the temperature in the room, and use paper that has been stored in a dry place.	—
Blank sheets are ejected. 	Are the originals loaded correctly?	When placing originals on the platen, place them face-down and align them with the original size indicator plates.	2-16
Full black printout or faint printing.  	—	Open the rear cover and press the points shown in the figure. If the problem is not solved even after printing several pages, call for service. 	—
Paper often jams.	Is the paper loaded correctly?	Load the paper correctly.	2-11, 2-12
	Is the paper of the supported type? Is it in good condition?	Remove the paper, turn it over, and reload it.	2-4
	Is the paper curled, folded or wrinkled?	Replace the paper with new paper.	2-4
	Are there any loose scraps or jammed paper in the machine?	Remove any jammed paper.	7-9
2 or more sheets are overlaps when ejected. (multi feed) 	—	Load the paper correctly.	2-11

Symptom	Checkpoints	Corrective Actions	Reference Page
Printouts are wrinkled. 	Is the paper damp?	Replace the paper with new paper.	2-4
Printouts are curled. 	Is the paper damp?	Replace the paper with new paper.	2-4
Text is missing on the Windows test page.	—	This is a problem specific to the Windows OS. It is not a machine problem. It does not affect print quality.	—
Printouts have dropouts or stray dots. 	Check the Drum charge setting in the Maintenance Menu.	Increase the adjustment value for the Drum charge setting in the Maintenance Menu.	6-7
	—	Run Drum refresh in the Maintenance Menu.	6-7
	—	The drum or developer unit may be damaged. If the problem is not solved even after printing several pages, call for service.	—
Printouts have vertical streaks 	—	The drum unit may be damaged. If the problem is not solved even after printing several pages, call for service.	—
Faint or blurred printing. 	Check the toner container.	If necessary, replace the toner container.	6-2
	Check the Print density setting in KYOCERA Client Tool.	Increase the adjustment value for the Print density setting in KYOCERA Client Tool.	2-38
	Check the Drum charge setting in the Maintenance Menu.	Decrease the adjustment value for the Drum charge setting in the Maintenance Menu.	6-7

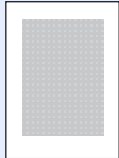
Symptom	Checkpoints	Corrective Actions	Reference Page
<p>The altitude is 1500 m or higher and printouts are too light.</p> 	<p>Check the Altitude Setting in the Maintenance Menu.</p>	<p>Set the Altitude Setting in the Maintenance Menu to 1. If there is still no improvement, change the value to 2.</p>	6-7
<p>Gray background.</p> 	<p>Check the toner container.</p>	<p>If necessary, replace the toner container.</p>	6-2
	<p>Check the Drum charge setting in the Maintenance Menu.</p>	<p>Increase the adjustment value for the Drum charge setting in the Maintenance Menu.</p>	6-7
	<p>—</p>	<p>Run Drum refresh in the Maintenance Menu.</p>	6-7
	<p>Check the Print density setting in KYOCERA Client Tool.</p>	<p>Decrease the adjustment value for Print density in KYOCERA Client Tool.</p>	2-38
<p>Dirt on the top edge or back of the paper.</p> 	<p>Check the Drum charge setting in the Maintenance Menu.</p>	<p>Increase the adjustment value for the Drum charge setting in the Maintenance Menu.</p>	6-7
	<p>Is the interior of the machine dirty?</p>	<p>If the problem is not solved even after printing several pages, clean the rollers, conveying unit and paper feed unit.</p> <p>If the problem is not solved after cleaning, call for service.</p>	6-5
<p>The previous image remains and lightly printed on the prepunched paper.</p> 	<p>Check the Drum charge setting in the Maintenance Menu.</p>	<p>Increase the adjustment value for the Drum charge setting in the Maintenance Menu.</p> <p>Increase the adjustment value 1 level at a time from the current value.</p> <p>If there is no improvement after the value is increased by 1 level, increase by 1 level again.</p> <p>If there is still no improvement, return the setting to the original value.</p>	6-7
<p>Gray background with horizontal streaks near the top edge.</p> 	<p>Check the Drum charge setting in the Maintenance Menu.</p>	<p>Increase the adjustment value for the Drum charge setting in the Maintenance Menu.</p>	6-7

Symptom	Checkpoints	Corrective Actions	Reference Page
<p>Copies have a moire pattern (dots grouped together in patterns and not aligned uniformly).</p> 	Is the original a printed photograph?	Set the image quality to Photo .	2-30
<p>Texts are not clearly printed.</p> 	Did you choose appropriate image quality for the original?	Select appropriate image quality.	2-30
<p>Images are skewed.</p> 	Are the originals placed correctly?	When placing originals on the platen, align them with the original size indicator plates.	2-16
	Is the paper loaded correctly?	Check the position of the paper width guides.	2-12
	Are the application software settings at the PC set properly?	Check that the printing settings are correct in the application software and the printer driver.	—
<p>Cannot scan.</p>	Check the interface cable.	Connect both ends of the interface cable securely. Try replacing the interface cable.	2-2
	Is the save location correctly specified?	Check the path to the folder where the scanned image will be saved.	2-34

Tips

Machine problems may be solved easily by following the tips below. When you have encountered a problem that cannot be solved following the guidelines above, try the following:

- Restart the computer you are using to send print jobs to the machine.
- Obtain and use the latest version of the printer driver. The latest versions of printer drivers and utilities are available at: <http://www.kyoceradocumentsolutions.com>.
- Make sure that the procedures for printing are correctly followed in the application software. Consult the documentation supplied with the application software.

Error Messages

If a problem has occurred in the machine, you will be notified by the following display.

- The **Attention** indicator on the operation panel is lit or flashing.
- An error code appears in the display on the operation panel.
- KYOCERA Client Tool and Status Monitor will show the status of the machine.

If the **Attention** indicator is lit or flashing and an error code appears in the display on the operation panel, check the KYOCERA Client Tool or Status Monitor.

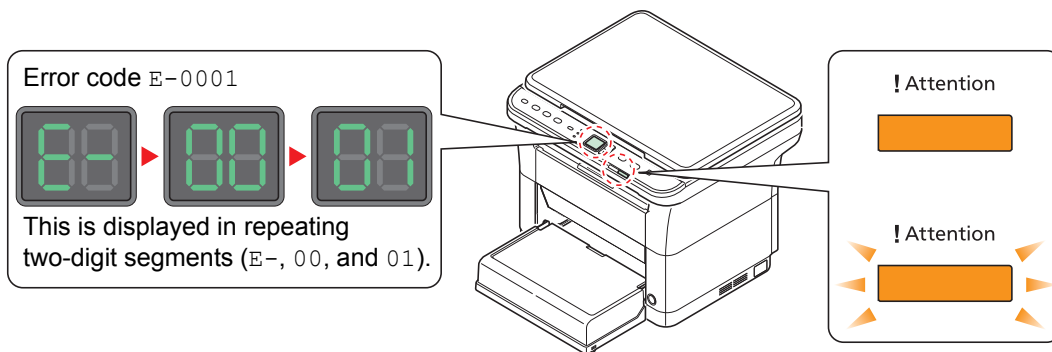

Note If the indicators light or flash repeatedly in manners not described above, a service error has probably occurred. Turn off the power, unplug the power cord, and then plug the power cord back in and turn on the power. This may clear the error. Even if the error is not cleared, contact your service representative.

Problems that can be resolved by the user are described below.

Error Code	Message displayed in KYOCERA Client Tool and Status Monitor*	Meaning	Remedy
C-F040	Error has occurred	An error has occurred in the machine.	Turn the power off and then on.
C-#### (except C-F040)	Error has occurred	An error has occurred in the machine.	Make a note of the error code displayed on the operation panel, and contact your service representative.
E-0001	Non-genuine toner is installed	The installed toner container is non-genuine.	The manufacturer assumes no responsibility for damage caused by a non-genuine toner. We recommend that you only use genuine toner containers. When you want to use the toner container currently installed, press the Mode Select key and [Stop/Reset] simultaneously for 3 seconds or more.
E-0002	Error has occurred	The installed toner container's regional specification does not match the machine's.	Install the specified toner container.
E-0003	Memory full	Scanning cannot be performed due to insufficient memory of scanner.	Only the scanned pages are available. Press [Stop/Reset] and the job will be canceled.
E-0004	Error has occurred	The number of scanned pages exceeds the maximum number.	The maximum number of scanned original pages is 99. Only the scanned pages are available. Press [Stop/Reset] and the job will be canceled.
E-0007	Add toner	The toner has run out.	Replace with a new toner container.

Error Code	Message displayed in KYOCERA Client Tool and Status Monitor*	Meaning	Remedy
E-0008	Cover open	The rear cover or front cover is open.	Close the rear cover or front cover.
E-0009	Inner tray full	The inner tray is full of paper.	The machine pauses after 100 sheets are printed. Remove paper from the inner tray and press [Start] to resume printing.
E-0012	Memory overflow	Unable to continue the job as the memory is used up.	Change the print resolution from Fast 1200 to 600 dpi. Refer to <i>Printer Driver User Guide</i> .
E-0014	Add paper	The paper size in the paper source is different from the printer driver or KYOCERA Client Tool setting.	Load the proper size of paper in the paper source.
E-0015	—	The USB cable is not connected.	Press [Stop/Reset] and connect the USB cable.
		The PC is powered off.	Press [Stop/Reset] and turn the PC power on.
		Cannot find KYOCERA Client Tool.	Press [Stop/Reset] and open KYOCERA Client Tool.
—	Not connected.	The USB cable is not connected.	Connect the USB cable.
		The machine is powered off.	Turn the machine power on.
		Cannot find the appropriate driver.	Install the appropriate driver.
E-0018	—	The file does not exist in Print Box.	Press [Stop/Reset] .
E-0019	—	The machine cannot run this program due to unusable original size is registered in the program.	Press [Stop/Reset] and change the program settings.
J-0511	Paper jam	A paper jam has occurred in the rear cover.	Refer to <i>Clearing Paper Jams</i> on page 7-9 and remove the jammed paper.
PF	Add paper	A paper jam has occurred in the cassette.	Refer to <i>Clearing Paper Jams</i> on page 7-9 and remove the jammed paper.
		There is no paper in the paper source.	Load paper into the paper source.
—	Toner is running out.	It is almost time to replace the toner container.	Obtain a new toner container.
—	Replacing the Maintenance Kit	Replacement of the maintenance kit is necessary at every 100,000 images of printing.	Replace Maintenance Kit.

* Events for which the Status Monitor provides notification can be set in the Configuration. Refer to *Configuration* on page 2-36.

Clearing Paper Jams

If paper jams in the paper transport system, or no paper sheets are fed at all, the machine automatically goes offline, and the **Attention** indicator will flash. KYOCERA Client Tool can indicate the location of the paper jam (the component where the paper jam has occurred). Remove the paper jam. After removing the paper jam, the machine will resume printing.

Possible Paper Jam Locations

Detailed paper jam positions are as follows. Refer to the indicated page number to remove the paper jam.

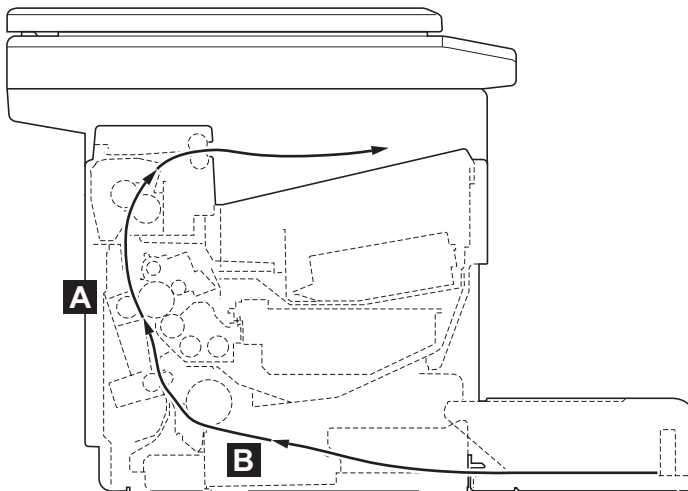

Paper Jam Locations	Error Code	Message displayed in KYOCERA Client Tool and Status Monitor	Description	Reference page
A	J-0511	Paper jam	A paper jam has occurred in the rear cover.	7-10, 7-11
B	PF*	Add paper	A paper jam has occurred in the cassette.	7-12, 7-13

* PF also appears when the paper has run out. In this case, add paper. Refer to *Loading Paper* on page 2-4.

General Considerations for Clearing Jams

Bear in mind the following considerations when attempting paper jam removal:



CAUTION When removing a paper jam, pull the paper gently so as not to tear it. Torn pieces of paper are difficult to remove and may be easily overlooked, deterring the paper jam recovery.

- If paper jams occur frequently, try using a different type of paper, replace the paper with paper from another ream, or flip the paper stack over. The machine may have problems if paper jams recur after the paper is replaced.
- Whether or not the jammed pages are reproduced normally after printing is resumed, depends on the location of the paper jam.

Rear Cover

Follow the steps below to clear paper jams inside the rear cover.

 **Note** When the front cover is opened or closed, the paper inside the machine may be discharged.

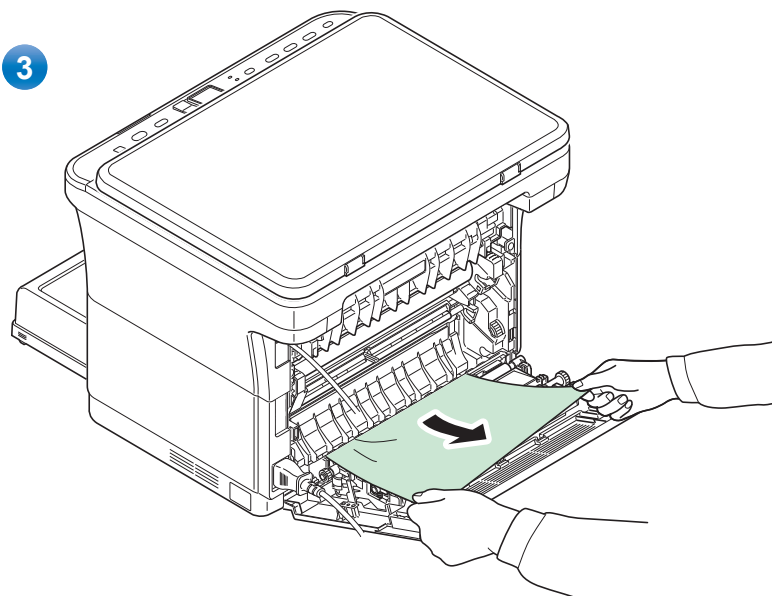
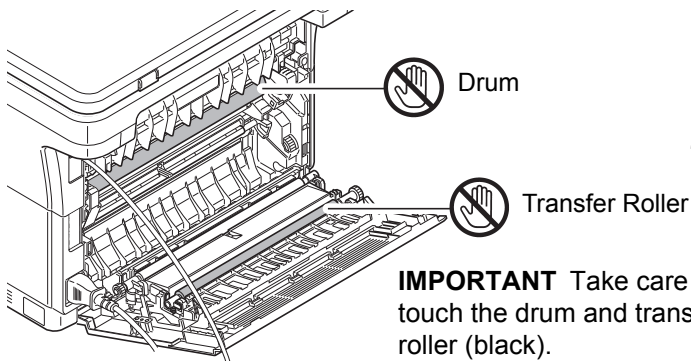
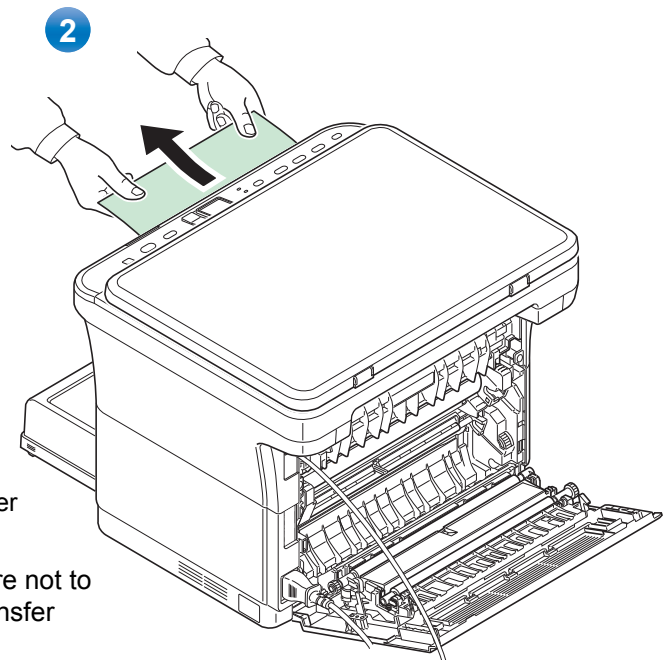
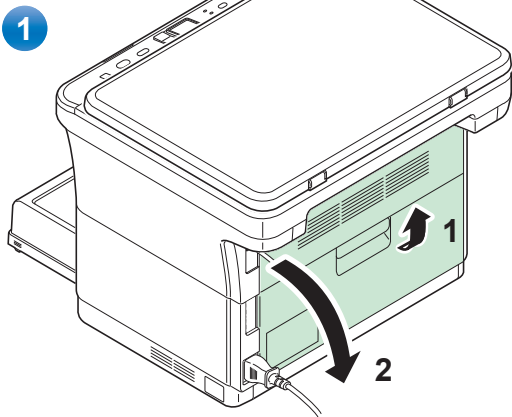
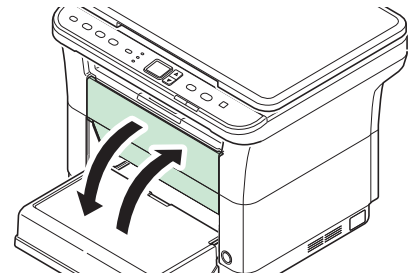

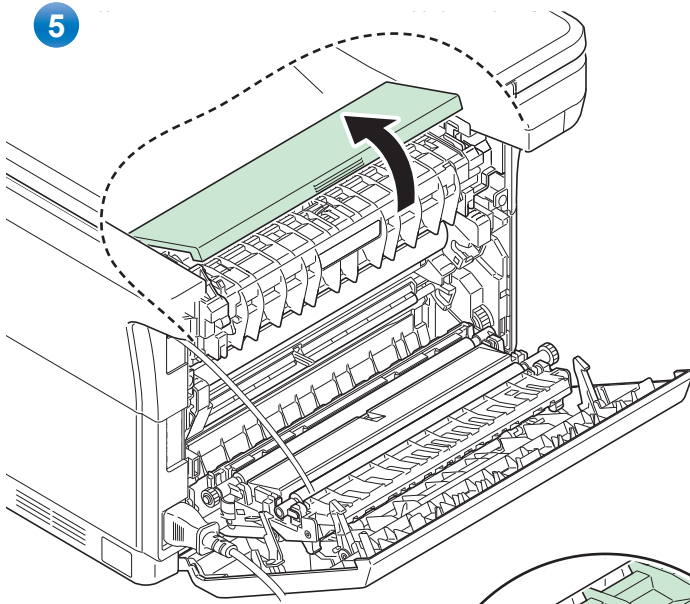

CAUTION The fuser unit inside the machine is hot. Do not touch it, as it may result in burn injury.

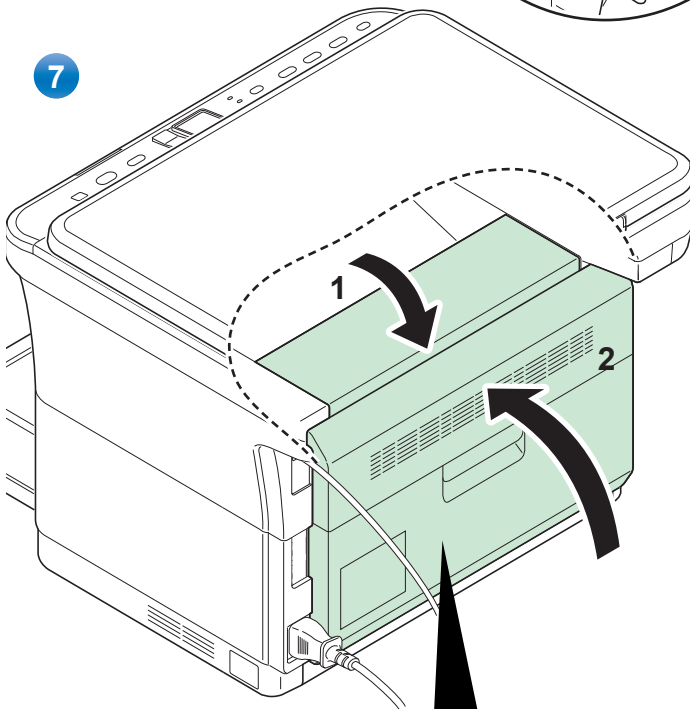
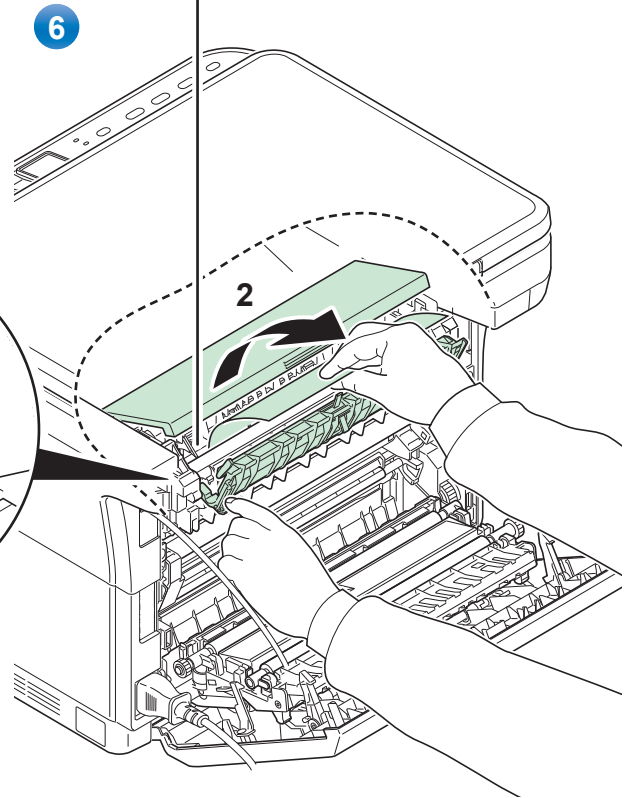
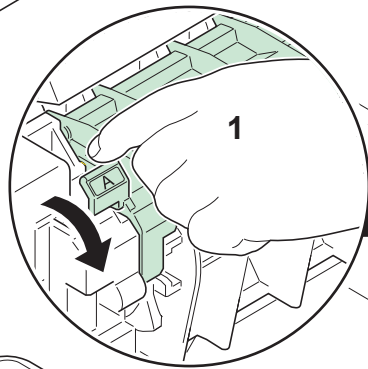

Close the rear cover to clear the error. The machine warms up and resumes printing.

Note Close the top cover first and then close the rear cover.

Cassette

Follow the steps below to clear paper jams in the cassette.

IMPORTANT Do not try to remove paper that has already been partially fed. Refer to *Rear Cover* on page 7-10.

 **Note** Do not open or close the front cover or rear cover before removing the jammed paper.

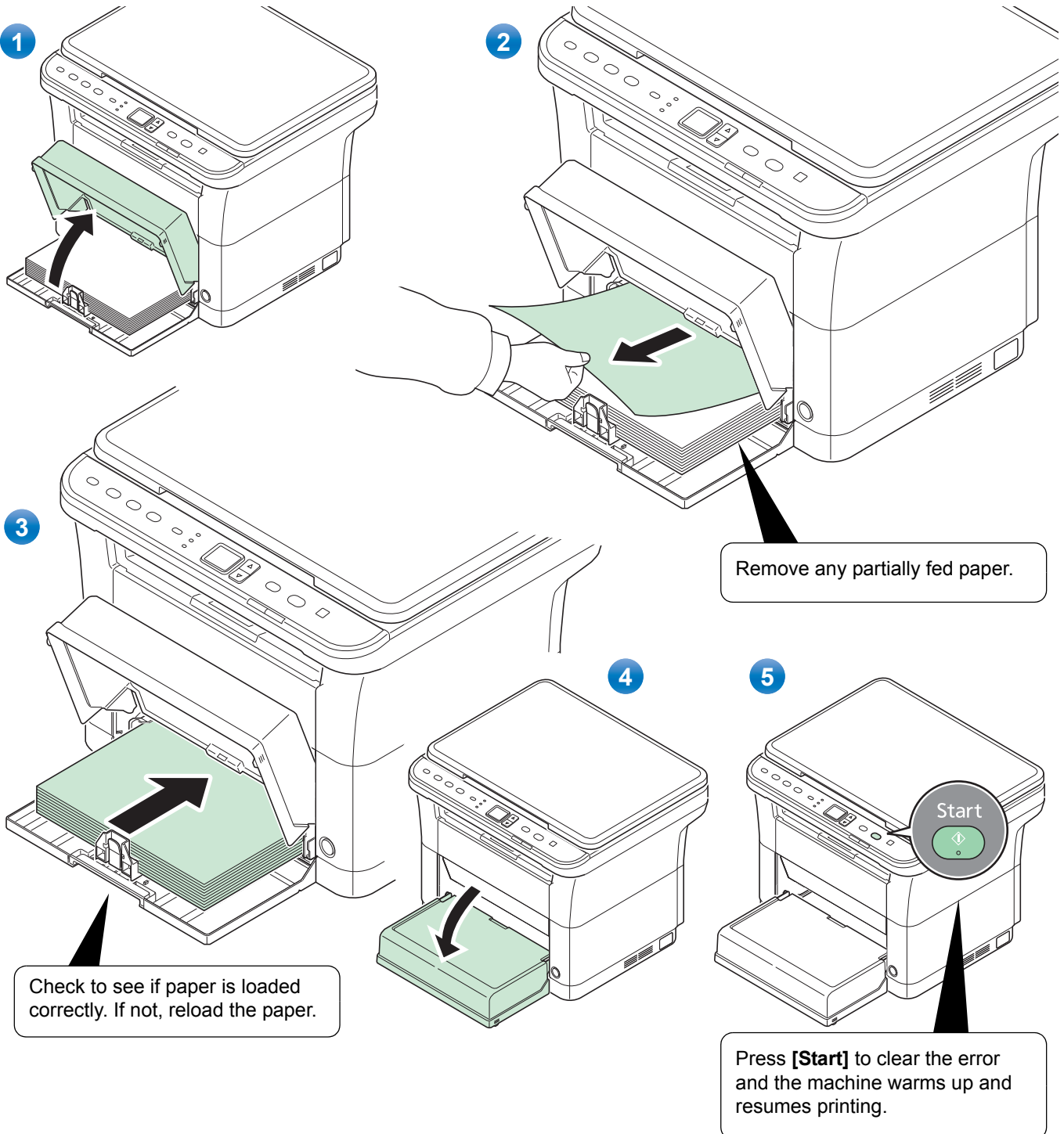

If paper feed failure occurs

Check on and reduction of number of paper sheets loaded

If an excessive amount of thick paper is loaded in the cassette, it may not be fed. In that case, reduce the number of sheets to be loaded.

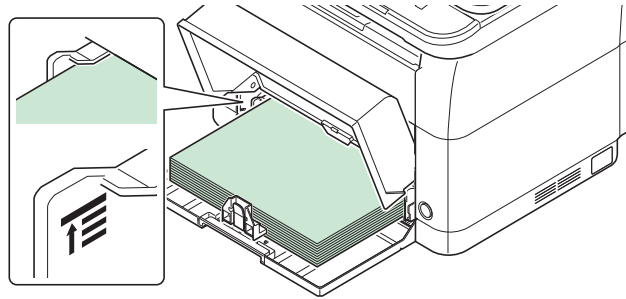

Edge fanning and curl straightening

Remove all the even pages (including the instruction sheet) from the inner tray, fan through the sheets to separate them prior to loading.

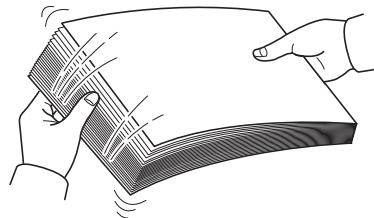

If the paper is curled at an edge, straighten it prior to reloading.

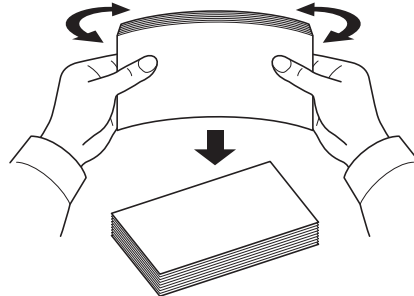

No paper feed due to wavy paper edge

When the paper feed fails because the edge of the paper is wavy, turn it upside down and load it again.

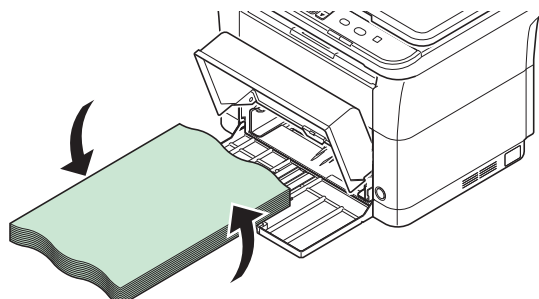

8 Appendix

This chapter explains the following topics:

Specifications 8-2

Specifications



Note These specifications are subject to change without notice.

Common Functions

Item		Description
Type		Desktop
Printing Method		Electrophotography by semiconductor laser
Paper Weight		60 to 220 g/m ²
Paper Type		Plain, Preprinted, Labels, Bond, Recycled, Vellum, Rough, Letterhead, Color, Prepunched, Envelope, Cardstock, Thick paper, High Quality, Custom 1 to 8
Warm-up Time (22°C/71.6°F, 60%RH)	Power on	20 seconds or less
	Sleep	12 seconds or less
Paper Capacity		250 sheets (80 g/m ²)
Inner Tray Capacity	Standard paper	100 sheets (80 g/m ²) (The machine pauses after 100 sheets are printed.)
	Special paper	1 sheet
Continuous Copying		1 to 99 sheets
Image Write System		Semiconductor laser and electrophotography
Memory		ROM: 32 MB, RAM: 64 MB
Interface		USB Interface Connector: 1 (Hi-Speed USB)
Operating Environment	Temperature	10 to 32.5°C/50 to 90.5°F
	Humidity	15 to 80%
	Altitude	3,500 m/11,482.8 ft maximum
	Brightness	1,500 lux maximum
Dimension (W × D × H)		390 × 333 × 317 mm 15-3/8 × 13-1/8 × 12-1/2"
Weight (with toner container)		8.7 kg/19.14 lb
Space Required (W × D)		390 × 645 mm 15-3/8 × 25-3/8"
Power Requirements		230 V Specification Model: 220 to 240 V (50 Hz/60 Hz, 3.1 A) 120 V Specification Model: 120 V (60 Hz, 6.0 A)

Copy Functions

Item	Description
Paper Size	A4, A5, A6, Folio, JIS B5, ISO B5, Letter, Legal, Statement, Executive, Oficio II (216 × 340 mm, 8-1/2 × 13 inches), 216 × 340 mm, 16 K, Custom (70 × 148 to 216 × 356 mm, 2-3/4 × 5-13/16 to 8-1/2 × 14 inches)
Copying Speed (300 × 300 dpi)	A4 Light (63 g/m ² or less): 20 images/min Normal 1 (64 to 69 g/m ²): 20 images/min Normal 2 (3) (70 to 105 g/m ²): 20 images/min
	A4 (Quiet Mode) Light (63 g/m ² or less): 15 images/min Normal 1 (64 to 69 g/m ²): 15 images/min Normal 2 (3) (70 to 105 g/m ²): 15 images/min Heavy 1 (106 to 135 g/m ²): 14 images/min Heavy 2 (3) (136 to 220 g/m ²): 13 images/min
	Letter Light (63 g/m ² or less): 21 images/min Normal 1 (64 to 69 g/m ²): 21 images/min Normal 2 (3) (70 to 105 g/m ²): 21 images/min
	Letter (Quiet Mode) Light (63 g/m ² or less): 16 images/min Normal 1 (64 to 69 g/m ²): 16 images/min Normal 2 (3) (70 to 105 g/m ²): 16 images/min Heavy 1 (106 to 135 g/m ²): 14 images/min Heavy 2 (3) (136 to 220 g/m ²): 13 images/min
	A5/B5/A6 (Quiet Mode) Light (63 g/m ² or less): 12 images/min Normal 1 (64 to 69 g/m ²): 12 images/min Normal 2 (3) (70 to 105 g/m ²): 12 images/min Heavy 1 (106 to 135 g/m ²): 10 images/min Heavy 2 (3) (136 to 220 g/m ²): 9 images/min
	A5/B5/A6 (from 11th image) (Quiet Mode) Light (63 g/m ² or less): 10 images/min Normal 1 (64 to 69 g/m ²): 10 images/min Normal 2 (3) (70 to 105 g/m ²): 10 images/min Heavy 1 (106 to 135 g/m ²): 8 images/min Heavy 2 (3) (136 to 220 g/m ²): 8 images/min
First Print Time (A4, feed from cassette)	12 seconds or less
Zoom Level	25 to 400%, 1% increments
Resolution	600 × 600 dpi
Supported Original Types	Sheet, Book, 3-dimensional objects (maximum original size: A4/Letter)
Original Feed System	Fixed

Printer Functions

Item	Description																
Paper Size	A4, A5, A6, Folio, JIS B5, ISO B5, Letter, Legal, Statement, Executive, Envelope Monarch, Envelope #10, Envelope #9, Envelope #6-3/4, Envelope C5, Envelope DL, Oficio II (216 × 340 mm, 8-1/2 × 13 inches), 216 × 340 mm, 16 K, Custom (70 × 148 to 216 × 356 mm, 2-3/4 × 5-13/16 to 8-1/2 × 14 inches)																
Printing Speed	<table border="1"> <tr> <td data-bbox="339 510 644 629">A4</td> <td data-bbox="644 510 1481 629">Light (63 g/m² or less): 20 images/min Normal 1 (64 to 69 g/m²): 20 images/min Normal 2 (3) (70 to 105 g/m²): 20 images/min</td> </tr> <tr> <td data-bbox="339 629 644 819">A4 (Quiet Mode)</td> <td data-bbox="644 629 1481 819">Light (63 g/m² or less): 15 images/min Normal 1 (64 to 69 g/m²): 15 images/min Normal 2 (3) (70 to 105 g/m²): 15 images/min Heavy 1 (106 to 135 g/m²): 14 images/min Heavy 2 (3) (136 to 220 g/m²): 13 images/min</td> </tr> <tr> <td data-bbox="339 819 644 940">Letter</td> <td data-bbox="644 819 1481 940">Light (63 g/m² or less): 21 images/min Normal 1 (64 to 69 g/m²): 21 images/min Normal 2 (3) (70 to 105 g/m²): 21 images/min</td> </tr> <tr> <td data-bbox="339 940 644 1131">Letter (Quiet Mode)</td> <td data-bbox="644 940 1481 1131">Light (63 g/m² or less): 16 images/min Normal 1 (64 to 69 g/m²): 16 images/min Normal 2 (3) (70 to 105 g/m²): 16 images/min Heavy 1 (106 to 135 g/m²): 14 images/min Heavy 2 (3) (136 to 220 g/m²): 13 images/min</td> </tr> <tr> <td data-bbox="339 1131 644 1321">A5/B5/A6 (Quiet Mode)</td> <td data-bbox="644 1131 1481 1321">Light (63 g/m² or less): 12 images/min Normal 1 (64 to 69 g/m²): 12 images/min Normal 2 (3) (70 to 105 g/m²): 12 images/min Heavy 1 (106 to 135 g/m²): 10 images/min Heavy 2 (3) (136 to 220 g/m²): 9 images/min</td> </tr> <tr> <td data-bbox="339 1321 644 1512">A5/B5/A6 (from 11th image) (Quiet Mode)</td> <td data-bbox="644 1321 1481 1512">Light (63 g/m² or less): 10 images/min Normal 1 (64 to 69 g/m²): 10 images/min Normal 2 (3) (70 to 105 g/m²): 10 images/min Heavy 1 (106 to 135 g/m²): 8 images/min Heavy 2 (3) (136 to 220 g/m²): 8 images/min</td> </tr> <tr> <td data-bbox="339 1512 644 1632">Legal</td> <td data-bbox="644 1512 1481 1632">Light (63 g/m² or less): 13 images/min Normal 1 (64 to 69 g/m²): 13 images/min Normal 2 (3) (70 to 105 g/m²): 13 images/min</td> </tr> <tr> <td data-bbox="339 1632 644 1816">Legal (Quiet Mode)</td> <td data-bbox="644 1632 1481 1816">Light (63 g/m² or less): 12 images/min Normal 1 (64 to 69 g/m²): 12 images/min Normal 2 (3) (70 to 105 g/m²): 12 images/min Heavy 1 (106 to 135 g/m²): 11 images/min Heavy 2 (3) (136 to 220 g/m²): 10 images/min</td> </tr> </table>	A4	Light (63 g/m ² or less): 20 images/min Normal 1 (64 to 69 g/m ²): 20 images/min Normal 2 (3) (70 to 105 g/m ²): 20 images/min	A4 (Quiet Mode)	Light (63 g/m ² or less): 15 images/min Normal 1 (64 to 69 g/m ²): 15 images/min Normal 2 (3) (70 to 105 g/m ²): 15 images/min Heavy 1 (106 to 135 g/m ²): 14 images/min Heavy 2 (3) (136 to 220 g/m ²): 13 images/min	Letter	Light (63 g/m ² or less): 21 images/min Normal 1 (64 to 69 g/m ²): 21 images/min Normal 2 (3) (70 to 105 g/m ²): 21 images/min	Letter (Quiet Mode)	Light (63 g/m ² or less): 16 images/min Normal 1 (64 to 69 g/m ²): 16 images/min Normal 2 (3) (70 to 105 g/m ²): 16 images/min Heavy 1 (106 to 135 g/m ²): 14 images/min Heavy 2 (3) (136 to 220 g/m ²): 13 images/min	A5/B5/A6 (Quiet Mode)	Light (63 g/m ² or less): 12 images/min Normal 1 (64 to 69 g/m ²): 12 images/min Normal 2 (3) (70 to 105 g/m ²): 12 images/min Heavy 1 (106 to 135 g/m ²): 10 images/min Heavy 2 (3) (136 to 220 g/m ²): 9 images/min	A5/B5/A6 (from 11th image) (Quiet Mode)	Light (63 g/m ² or less): 10 images/min Normal 1 (64 to 69 g/m ²): 10 images/min Normal 2 (3) (70 to 105 g/m ²): 10 images/min Heavy 1 (106 to 135 g/m ²): 8 images/min Heavy 2 (3) (136 to 220 g/m ²): 8 images/min	Legal	Light (63 g/m ² or less): 13 images/min Normal 1 (64 to 69 g/m ²): 13 images/min Normal 2 (3) (70 to 105 g/m ²): 13 images/min	Legal (Quiet Mode)	Light (63 g/m ² or less): 12 images/min Normal 1 (64 to 69 g/m ²): 12 images/min Normal 2 (3) (70 to 105 g/m ²): 12 images/min Heavy 1 (106 to 135 g/m ²): 11 images/min Heavy 2 (3) (136 to 220 g/m ²): 10 images/min
A4	Light (63 g/m ² or less): 20 images/min Normal 1 (64 to 69 g/m ²): 20 images/min Normal 2 (3) (70 to 105 g/m ²): 20 images/min																
A4 (Quiet Mode)	Light (63 g/m ² or less): 15 images/min Normal 1 (64 to 69 g/m ²): 15 images/min Normal 2 (3) (70 to 105 g/m ²): 15 images/min Heavy 1 (106 to 135 g/m ²): 14 images/min Heavy 2 (3) (136 to 220 g/m ²): 13 images/min																
Letter	Light (63 g/m ² or less): 21 images/min Normal 1 (64 to 69 g/m ²): 21 images/min Normal 2 (3) (70 to 105 g/m ²): 21 images/min																
Letter (Quiet Mode)	Light (63 g/m ² or less): 16 images/min Normal 1 (64 to 69 g/m ²): 16 images/min Normal 2 (3) (70 to 105 g/m ²): 16 images/min Heavy 1 (106 to 135 g/m ²): 14 images/min Heavy 2 (3) (136 to 220 g/m ²): 13 images/min																
A5/B5/A6 (Quiet Mode)	Light (63 g/m ² or less): 12 images/min Normal 1 (64 to 69 g/m ²): 12 images/min Normal 2 (3) (70 to 105 g/m ²): 12 images/min Heavy 1 (106 to 135 g/m ²): 10 images/min Heavy 2 (3) (136 to 220 g/m ²): 9 images/min																
A5/B5/A6 (from 11th image) (Quiet Mode)	Light (63 g/m ² or less): 10 images/min Normal 1 (64 to 69 g/m ²): 10 images/min Normal 2 (3) (70 to 105 g/m ²): 10 images/min Heavy 1 (106 to 135 g/m ²): 8 images/min Heavy 2 (3) (136 to 220 g/m ²): 8 images/min																
Legal	Light (63 g/m ² or less): 13 images/min Normal 1 (64 to 69 g/m ²): 13 images/min Normal 2 (3) (70 to 105 g/m ²): 13 images/min																
Legal (Quiet Mode)	Light (63 g/m ² or less): 12 images/min Normal 1 (64 to 69 g/m ²): 12 images/min Normal 2 (3) (70 to 105 g/m ²): 12 images/min Heavy 1 (106 to 135 g/m ²): 11 images/min Heavy 2 (3) (136 to 220 g/m ²): 10 images/min																
First Print Time (A4, feed from Cassette)	8.5 seconds or less																
Resolution	600 × 600 dpi/Fast 1200 dpi																
Controller	ARM926EJ 390MHz																
Supported OS	Windows XP, Windows Server 2003/R2, Windows Vista, Windows 7, Windows Server 2008/R2, Mac OS X 10.5 or higher																

Scanner Functions

Item	Description
System Requirements	CPU: 20 MHz RAM: 64 MB
Resolution	200 × 200 dpi, 300 × 300 dpi, 400 × 400 dpi, 600 × 600 dpi
File Format	BMP, JPEG, PNG, TIFF, PDF
Transmission System	PC transmission: Scan to Folder TWAIN scan* WIA scan**

* Available Operating System: Windows XP, Windows Server 2003/R2, Windows Vista, Windows 7, Windows Server 2008/R2

** Available Operating System: Windows Vista, Windows 7, Windows Server 2008/R2

Index

A	
Adhesive label	2-8
Attention Indicator operation panel	1-4
C	
Cassette	
basis weight	2-6
clearing paper jams	7-12
components	1-2
loading paper	2-12
paper sizes	2-5
paper type	2-11
Cassette cover	2-15
components	1-2
Cleaning	
interior of the machine	6-5
original cover, platen	6-5
Clearing paper jams	7-9
cassette	7-12
possible paper jam locations	7-9
rear cover section	7-10
Colored paper	2-10
Components	
at the front of the machine	1-2
at the rear of the machine	1-3
Configuration	2-36
Copy tab	2-40
Device Defaults tab	2-38
Status Monitor tab	2-41
Connection	
power cord	2-2
USB cable	2-2
Copies indicator	
operation panel	1-4
Copying	3-1
basic operation	3-2
functions	3-5
ID Card Copy	3-6
manual duplex	3-3
programs	3-5
Copy key	
operation panel	1-4
D	
Default settings	2-28
Density indicator	
operation panel	1-4
E	
Energy Star	vi
Envelopes	2-9
Error messages	7-7
F	
Front cover	
components	1-2
I	
ID Card Copy	3-6
ID Card Copy key	
operation panel	1-4
Indicator	
Attention	1-4
Copies	1-4
Density	1-4
Processing	1-4
Program	1-4
Inner tray	
components	1-2
Install the software	
Macintosh	2-19
Windows	2-18
Instruction sheet	
manual duplex	4-4
K	
Key	
Copy	1-4
ID Card Copy	1-4
Mode Select	1-4
Print Box	1-4
Quiet Mode	1-4
Scan	1-4
Start	1-4
Stop/Reset	1-4
KYOCERA Client Tool	2-22
L	
Label	2-8
Loading originals	2-16
Loading paper	
cassette	2-12
M	
Machine parts	1-1
Maintenance	6-1
cleaning	6-5
maintenance kit replacement	6-5
maintenance menu	6-7
toner container replacement	6-2
Maintenance kit	
replacement	6-5
Maintenance menu	6-7
Manual duplex	
copying	3-3

printing	4-3
Mode Select key	
operation panel	1-4
Moving machine	6-8

O

Operation panel	
components	1-2
indicators, keys, overview	1-4
Original cover	
cleaning	6-5
components	1-2
Original size indicator plates	
components	1-2

P

Paper	
minimum and maximum sizes	2-5
Paper length guide	2-13
Paper stopper	2-12
components	1-2
Paper weight	2-6
Paper width guide	2-12
Platen	
cleaning	6-5
components	1-2
Postcards	2-9
Power cord	
connection	2-2
Power cord connector	
components	1-3
Power switch	
components	1-2
Preparation	2-1
Preparing paper	2-11
Preprinted paper	2-10
Preset Tool	2-28
Print Box	4-5
printing	4-6
saving	4-5
Print Box key	
operation panel	1-4
Printing	4-1
manual duplex	4-3
printer driver	4-2
printing from Application Software	4-2
Processing Indicator	
operation panel	1-4
Program indicator	
operation panel	1-4
Programs	
copying	3-5
registering	2-28
scanning	5-3
Prolonged non-use	6-8
Push Scan	5-2

Q

Quick Scan	
settings	2-34
using	5-4
Quiet Mode	1-4
Quiet Mode key	
operation panel	1-4

R

Rear cover	
components	1-3
Rear cover section	
clearing paper jams	7-10
Recycled paper	2-10
Replacement	
maintenance kit	6-5
toner container	6-2

S

Scan key	
operation panel	1-4
Scanning	5-1
programs	5-3
Push Scan	5-2
Quick Scan	5-4
TWAIN/WIA	5-5
Software	2-17
Solving malfunctions	7-2
Special paper	2-8
Specifications	8-2
common functions	8-2
copy	8-3
printer	8-4
scanner	8-5
Start key	
operation panel	1-4
Status Monitor	2-27
Status page	
printing	1-4, 2-42
Stop/Reset key	
operation panel	1-4

T

Thick paper	2-10
Tips	7-6
Toner container	
how to replace	6-3
replacement	6-2
Toner kit	
toner container, plastic waste bag, installation guide	6-2
Troubleshooting	7-1
clearing paper jams	7-9
error messages	7-7
solving malfunctions	7-2
Turning on the power	2-3
TWAIN/WIA	5-5

U

Uninstalling drivers and utilities	2-21
USB cable	
connection	2-2
USB interface connector	
components	1-3

**QUALITY
CERTIFICATE**

This machine has passed
all quality controls and
final inspection.

KYOCERA Document Solutions America, Inc.**Headquarters**

225 Sand Road,
Fairfield, New Jersey 07004-0008, USA
Phone: +1-973-808-8444
Fax: +1-973-882-6000

Latin America

8240 NW 52nd Terrace Dawson Building, Suite 100
Miami, Florida 33166, USA
Phone: +1-305-421-6640
Fax: +1-305-421-6666

KYOCERA Document Solutions Canada, Ltd.

6120 Kestrel Rd., Mississauga, ON L5T 1S8,
Canada
Phone: +1-905-670-4425
Fax: +1-905-670-8116

**KYOCERA Document Solutions
Mexico, S.A. de C.V.**

Calle Arquimedes No. 130, 4 Piso, Colonia Polanco
Chapultepec, Delegacion Miguel Hidalgo,
Distrito Federal, C.P. 11560, México
Phone: +52-555-383-2741
Fax: +52-555-383-7804

KYOCERA Document Solutions Brazil, Ltda.

Av. Tambore, 1180 Mod.B-09 CEP 06460-000
Tambore-Barueri-SP, Brazil
Phone: +55-11-4195-8496
Fax: +55-11-4195-6167

**KYOCERA Document Solutions
Australia Pty. Ltd.**

Level 3, 6-10 Talavera Road North Ryde N.S.W, 2113,
Australia
Phone: +61-2-9888-9999
Fax: +61-2-9888-9588

**KYOCERA Document Solutions
New Zealand Ltd.**

1-3 Parkhead Place, Albany, Auckland 1330,
New Zealand
Phone: +64-9-415-4517
Fax: +64-9-415-4597

KYOCERA Document Solutions Asia Limited

16/F., Mita Centre, 552-566, Castle Peak Road
Tsuenwan, NT, Hong Kong
Phone: +852-2610-2181
Fax: +852-2610-2063

**KYOCERA Document Solutions
(Thailand) Corp., Ltd.**

335 Ratchadapisek Road, Bangsue, Bangkok 10800,
Thailand
Phone: +66-2-586-0333
Fax: +66-2-586-0278

**KYOCERA Document Solutions
Singapore Pte. Ltd.**

12 Tai Seng Street #04-01A,
Luxasia Building, Singapore 534118
Phone: +65-6741-8733
Fax: +65-6748-3788

**KYOCERA Document Solutions
Hong Kong Limited**

16/F., Mita Centre, 552-566, Castle Peak Road
Tsuenwan, NT, Hong Kong
Phone: +852-2429-7422
Fax: +852-2423-2159

**KYOCERA Document Solutions
Taiwan Corporation**

6F., No.37, Sec. 3, Minquan E. Rd.,
Zhongshan Dist., Taipei 104, Taiwan R.O.C.
Phone: +886-2-2507-6709
Fax: +886-2-2507-8432

KYOCERA Document Solutions Korea Co., Ltd.

18F, Kangnam bldg, 1321-1,
Seocho-Dong, Seocho-Gu, Seoul, Korea
Phone: +822-6933-4050
Fax: +822-747-0084

**KYOCERA Document Solutions
India Private Limited**

First Floor, ORCHID CENTRE
Sector-53, Golf Course Road, Gurgaon 122 002,
India
Phone: +91-0124-4671000
Fax: +91-0124-4671001

KYOCERA Document Solutions Europe B.V.

Bloemlaan 4, 2132 NP Hoofddorp,
The Netherlands
Phone: +31-20-654-0000
Fax: +31-20-653-1256

KYOCERA Document Solutions Nederland B.V.

Beechavenue 25, 1119 RA Schiphol-Rijk,
The Netherlands
Phone: +31-20-5877200
Fax: +31-20-5877260

KYOCERA Document Solutions (U.K.) Limited

8 Beacontree Plaza,
Gillette Way Reading, Berkshire RG2 0BS,
United Kingdom
Phone: +44-118-931-1500
Fax: +44-118-931-1108

KYOCERA Document Solutions Italia S.p.A.

Via Verdi, 89/91 20063 Cernusco s/N.(MI),
Italy
Phone: +39-02-921791
Fax: +39-02-92179-600

KYOCERA Document Solutions Belgium N.V.

Sint-Martinusweg 199-201 1930 Zaventem,
Belgium
Phone: +32-2-7209270
Fax: +32-2-7208748

KYOCERA Document Solutions France S.A.S.

Espace Technologique de St Aubin
Route de l'Orme 91195 Gif-sur-Yvette CEDEX,
France
Phone: +33-1-69852600
Fax: +33-1-69853409

KYOCERA Document Solutions Espana, S.A.

Edificio Kyocera, Avda. de Manacor No.2,
28290 Las Matas (Madrid), Spain
Phone: +34-91-6318392
Fax: +34-91-6318219

KYOCERA Document Solutions Finland Oy

Atomitie 5C, 00370 Helsinki,
Finland
Phone: +358-9-47805200
Fax: +358-9-47805390

**KYOCERA Document Solutions
Europe B.V., Amsterdam (NL) Zürich Branch**

Hohlstrasse 614, 8048 Zürich,
Switzerland
Phone: +41-44-9084949
Fax: +41-44-9084950

**KYOCERA Document Solutions
Deutschland GmbH**

Otto-Hahn-Strasse 12, 40670 Meerbusch,
Germany
Phone: +49-2159-9180
Fax: +49-2159-918100

KYOCERA Document Solutions Austria GmbH

Eduard-Kittenberger-Gasse 95, 1230 Vienna,
Austria
Phone: +43-1-863380
Fax: +43-1-86338-400

KYOCERA Document Solutions Nordic AB

Esbogatan 16B 164 75 Kista, Sweden
Phone: +46-8-546-550-00
Fax: +46-8-546-550-10

KYOCERA Document Solutions Norge NUF

Postboks 150 Oppsal, 0619 Oslo,
Norway
Phone: +47-22-62-73-00
Fax: +47-22-62-72-00

KYOCERA Document Solutions Danmark A/S

Ejby Industrivej 60, DK-2600 Glostrup,
Denmark
Phone: +45-70223880
Fax: +45-45765850

KYOCERA Document Solutions Portugal Lda.

Rua do Centro Cultural, 41 (Alvalade) 1700-106 Lisboa,
Portugal
Phone: +351-21-843-6780
Fax: +351-21-849-3312

KYOCERA Document Solutions**South Africa (Pty) Ltd.**

49 Kyalami Boulevard,
Kyalami Business Park 1685 Midrand, South Africa
Phone: +27-11-540-2600
Fax: +27-11-466-3050

KYOCERA Document Solutions Russia LLC

Botanichesky pereulok 5, Moscow, 129090,
Russia
Phone: +7(495)741-0004
Fax: +7(495)741-0018

KYOCERA Document Solutions Middle East

Dubai Internet City, Bldg. 17,
Office 157 P.O. Box 500817, Dubai,
United Arab Emirates
Phone: +971-04-433-0412

KYOCERA Document Solutions Inc.

2-28, 1-chome, Tamatsukuri, Chuo-ku
Osaka 540-8585, Japan
Phone: +81-6-6764-3555
<http://www.kyoceradocumentsolutions.com>

